



KATALOG PRODUKTÓW METALOWYCH

KUCHINOX
INSPIRACJA PŁYNIE Z WNĘTRZA

KUCHINOX

INSPIRACJA PŁYNIE Z WNETRZA

MARKOWE KLAMKI

Katalog artykułów metalowych to materiał pełen inspiracji. Znajdą w nim Państwo klasyczne wzory i modne nowości.

To również kompendium wiedzy, w którym dzielimy się naszym wieloletnim doświadczeniem. W firmie Kuchinox wierzymy, że każdy szczegół ma znaczenie.

Przywiązujemy wagę do jakości surowców, detali wykończenia i funkcjonalności produktów.

W bogatej ofercie znajdą Państwo klamki, które będą ozdobą drzwi, niezależnie od stylu, w którym urządzony został dom. Prezentowane garderoby pomogą zagospodarować nawet niewielkie mieszkanie. A praktyczne artykuły metalowe ułatwią codzienne funkcjonowanie.

Wybór produktów Kuchinox do Państwa nowo urządzanego domu będzie dla nas zaszczytem.



Na okładce: klamka z serii QUBIK II,
wewnątrz: klamka z serii LUSIOS

SPIS TREŚCI

INFORMACJE TECHNICZNE 6

PODZIAŁ KLAMEK DRZWIOWYCH 9

SZYLD DŁUGI CZY DZIELONY? 11

STYLE KLAMEK 12

KLAMKI NA SZYLDZIE DZIELONYM 18

Szyld kwadratowy 20

ARIA II	20	QUBIK II	28	IWA	36
GLORIA	20	ROY	30	LUSIOS	37
LUGA	22	SAVIO	31	QUBIK	38
LUXOR II	22	SILANA	33	RANDO	38
MADERA	23	TALIA	34	SAMARIA	39
NERO	24	TIMOR	34	VERA	40
PARVA	25	AREUS	35		
PRIMA	27	BINGO	36		

Szyld okrągły 40

ELIKA	40	DUET	48	RETRO	53
GAŁKI	42	GEMELA	49	RODOS	54
TARA	44	GOA	49	STILO	54
VERDON	45	IRYS	50	ADA	55
ANDA	46	LUGA II	50	AGRA	55
ARIA	46	LUXOR	51	EWA	56
ASTER	47	MALTA	51	NOA	56
AURA	47	MARIO	52	STANDARD	57
DONA	48	MARS	52		

KLAMKI ZE STALI NIERDZEWNEJ 57

FARO	60	MEDA	61	WIGO	63
LAGOS	60	PORTO	62		

KLAMKI NA DŁUGIM SZYLDZIE 64

ADA	66	GOA	74	PARVA	80
AGRA	66	IRYS	74	PRIMA	81
ARIA	68	LUGA II	75	QUBIK	82
ASTER	69	LUXOR	76	RANDO	83
AURA	70	MADERA	77	RETRO	84
BINGO	71	MALTA	78	RODOS	85
EWA	72	NOA	79	STILO	86

KLAMKI ZEWNĘTRZNE 87

AURIS	88	FRIDA	90
FLOKO	88	IRMA	90

KLAMKI BRAMOWE 91

BARON	92	MAGNAT	93
-------	----	--------	----

SZYLDY 95

Szyldy kwadratowe	96
Szyldy okrągłe	102
Szyldy zewnętrzne	108

AKCESORIA 109

Odbojniki	110
Wkładki	112
Zestawy montażowe	112

GARDEROBY 113

Wieszaki	116	Stojaki na obuwie	120
MAJA	116	TOLA	120
Garderoby przenośne	116	TOLA BIS	120
PAULO	116	ZOJA	121
PAULO BIS	117	Akcesoria do garderoby	122
Garderoby stojące	117	FLORIDA	122
JACOB	117	JAMAJKA	124
LOFT II	118	MIAMI	126
LIVIA	119		
ZOSIA BIS	119		

INFORMACJE TECHNICZNE

Z CZEGO ZBUDOWANA JEST KLAMKA?

Klamka to dźwignia, z której każdy z nas korzysta codziennie. Zastanówmy się z czego składa się ten pozornie oczywisty element umieszczany w drzwiach.

KLAMKA (POCHWYT, RĘKOJEŚĆ)

Dźwignia sprzężona ze sprężyną i obrotowym trzpieniem przechodzącym przez drzwi. Poprzez jej naciśnięcie zostaje pokonany opór sprężyny, a obrotowy trzpień uruchamia mechanizm zapadki. Zapadka cofa się i drzwi zostają otwarte.

SZYLD (TARCZA, ROZETA)

Metalowa osłona połączona z klamką. Wyróżnia się szyldy długie (łączą klamkę i np. otwór na klucz za pomocą podłużnej, najczęściej prostokątnej części) i dzielone (szyld górny z klamką i szyld dolny np.: z otworem na klucz występują tu osobno).

ELEMENTY MONTAŻOWE

By prawidłowo przytwierdzić klamkę do drzwi, konieczne są elementy montażowe. Podstawowe z nich to wspomniane już obrotowe trzpień, śruby przelotowe oraz drewnowkręty.

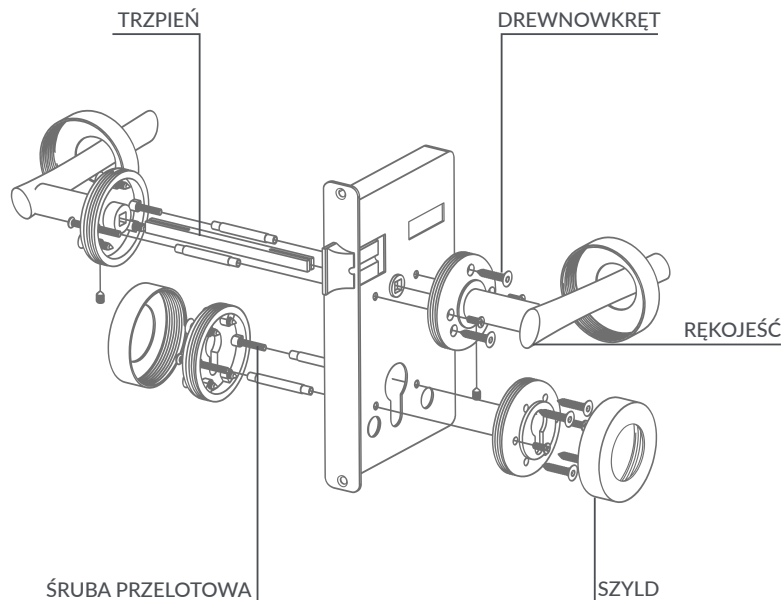

ROZSTAW

Rozstaw między otworem na trzpień klamki a otworem zamka jest istotną informacją przy wyborze właściwej klamki. Informację tę można znaleźć u producenta drzwi lub zmierzyć samodzielnie. Istnieje wiele rozstawów. Najpopularniejsze to 72 i 90 mm.

W katalogu rozstaw oznaczyliśmy dla całych grup produktów za pomocą strzałek.

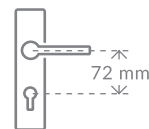

MONTAŻ KLAMEK

Kuchinox posiada w swojej ofercie bardzo szeroką gamę różnorodnych klamek na szyldach długich i na rozetach, dopasowanych do wymagań niemal każdego użytkownika. Ich jakość potwierdzona jest przez 5-letnią gwarancję producenta* i specjalne konstrukcje, które zapewniają pełne bezpieczeństwo użytkowania. Zaletą klamek Kuchinox jest także obecność w zestawie wszystkich elementów montażowych, dzięki czemu nie ponosi się żadnych dodatkowych kosztów.

Przedstawiamy instrukcje filmowe pokazujące, jak krok po kroku prawidłowo przytwierdzić poszczególne klamki do skrzydła drzwiowego.

* warunki gwarancyjne w karcie gwarancyjnej



INSTRUKCJA MONTAŻU KLAMKI NA ROZECIE

<https://youtu.be/dUDkXDhGgeU>



INSTRUKCJA MONTAŻU KLAMKI NA SZYLDZIE DŁUGIM

<https://youtu.be/9HAFFNnfdZc>

NIE TYLKO ALUMINIUM, CZYLI Z CZEGO PRODUKOWANE SĄ KLAMKI

Tworzywo użyte do wykonania klamki ma wpływ zarówno na jej wygląd, jak i trwałość. Obecnie najpopularniejsze są modele stalowe, aluminiowe, ze stali nierdzewnej, PCV i mosiądzu. Przyjrzyjmy się bliżej ich właściwościom.

ZNAL

to wytrzymały stop stworzony z połączenia cynku (Zn) i aluminium (Al). Ma zbliżone do aluminium właściwości, jednak posiada większe właściwości obróbcze i wykończeniowe, dzięki czemu jest chętnie używany do produkcji klamek.

ALUMINIUM

to metal stosunkowo wytrzymały i odporny na korozję. Klamki aluminiowe mogą być wykończone jako imitacja złota, polerowane, w matowym chromie oraz na wiele innych sposobów. Obecnie są to najczęściej spotykane rodzaje klamek.

TWORZYWO SZTUCZNE

charakteryzuje się tym, że klamki wykonane z niego są niedrogie, stosunkowo trwałe i łatwe do utrzymania w czystości. Montowane są najczęściej w biurach i obiektach użyteczności publicznej.



Wykonane z aluminium



Wykonane ze znu



Wykonane ze stali nierdzewnej

STAL

to materiał zdecydowanie droższy od powyższych, ale też zarazem bardziej masywny, trwały i odporny na uszkodzenia. Dlatego też często wykorzystuje się go w klamkach do drzwi zewnętrznych i pomieszczeń o dużym natężeniu ruchu. Ilość wykończeń oraz form nadawanych modelom stalowym jest niemal nieograniczona.

MOSIĄDZ

jest stopem używanym przede wszystkim do tworzenia klamek w stylu retro. Modele mosiężne są fantazyjnie odlane, bogato zdobione lub ciekawie stylizowane. Ich cechy to także masywność i dość wysokie ceny.

W katalogu materiał wykonania został oznaczony piktogramami:

PODZIAŁ KLAMEK DRZWIOWYCH ZE WZGLĘDU NA MIEJSCE ZASTOSOWANIA

Klamki dzielone są ze względu na kilka cech. Należą do nich tworzywo użyte do produkcji, stylistyka, a także miejsce zastosowania, o którym piszemy poniżej.

KLAMKI WEWNĘTRZNE DO POKOI

Podczas ich wyboru kluczową rolę odgrywa design, który musi być dopasowany zarówno do samych drzwi, jak i do wnętrza. Z powodzeniem można się tu zdecydować na klamki złote, ozdobione kryształami. Zalety, które również są tu istotne, to niewielka waga i ergonomia. Materiały wykorzystywane do produkcji klamek pokojowych to przede wszystkim stal i aluminium.



KLAMKI WEWNĘTRZNE DO ŁAZIENEK

Designem dopasowywane są do klamek pokojowych. Podstawową ich cechą jest obecność zamknięcia WC, który od strony wewnętrznej posiada uchwyt pozwalający na otwarcie / zamknięcie drzwi, zaś od strony zewnętrznej – mechanizm awaryjnego otwarcia.

KLAMKI WEWNĘTRZNE DO BIUR I POMIESZCZEŃ PUBLICZNYCH

Tu mniej liczy się design, ale bardziej podwyższona trwałość. Klamki w biurach są bowiem bardzo intensywnie użytkowane przez wiele osób. Warto więc wybierać modele wykonane na przykład ze stali nierdzewnej. Kluczowe kwestie to także łatwość czyszczenia i bezpieczeństwo, co zapewnią proste kształty.



KLAMKI DO DRZWI ZEWNĘTRZNYCH

Modele drzwiowe zewnętrzne są najbardziej wymagającymi z klamek. Ich cechami powinny być więc odporność na korozję i działanie czynników atmosferycznych oraz obecność zabezpieczeń antyrozwierceniowych. Odporność na korozję oznaczana jest klasami od 0 (najniższa) do 4 (najwyższa), identycznie rzecz ma się w przypadku antywłamaniowości. Co zaś do ogólnej wytrzymałości (zgodnie z normą EN 1906), najlepsze będą produkty określone 3 i 4 klasą kategorii użytkowania. Materiałem używanym do produkcji klamek zewnętrznych jest najczęściej stal, rzadziej aluminium.



KLAMKI DO BRAM I FURTEK

Jako że narażone są na stałe działanie niekorzystnych czynników zewnętrznych, powinny być wykonane z wytrzymałej stali i zabezpieczone poprzez np. precyzyjne malowanie proszkowe. Często z jednej strony szyldu znajduje się klamka, zaś z drugiej uchwyt, dzięki czemu nie jest możliwe otwarcie furtki czy bramy przez przypadkowego przechodnia. Cechą powyższych klamek jest też w większości osadzenie ich na szyldzie długim, w którego dolnej części znajduje się otwór na klucz do wkładki bębnekowej.

SZYLD DŁUGI CZY DZIELONY?

JAK WYBIERAMY KLAMKI

Na klamkę składa się nie tylko rękojeść i mechanizm sprężynowy odpowiedzialny za jej prawidłową pracę. Nieodłączną częścią klamkowego zestawu są też szyldy (tarcze, osłony, rozety), łączone z klamkami za pomocą trzpieni. Główny ich podział to ten na szyldy długie i szyldy dzielone. Czym charakteryzują się poszczególne z nich? Który wybrać do swojego domu lub mieszkania?

SZYLDY DŁUGIE

Modele te łączą klamkę i np. otwór na klucz za pomocą podłużnej, najczęściej prostokątnej części. Podczas ich zakupu należy więc znać dokładny rozstaw zamka. Wizualnie sprawiają wrażenie solidniejszych od szyldów krótkich (jest to jednak wyłącznie wrażenie). Szyldy długie występują w czterech wersjach:

- z otworem na klucz,
- z otworem na wkładkę bębnową (zamek),
- z blokadą WC,
- bez otworów (szyldy pokojowe).

W przypadku skrzydeł wewnętrznych decyzja zależy natomiast wyłącznie od gustu użytkownika.

SZYLDY KRÓTKIE

W tym wypadku klamka (szyld górny) i zamek (szyld dolny)

występują osobno, łatwiej je więc dopasować jeśli chodzi o rozstaw klamki i zamka. Często w drzwiach pokojowych nie ma potrzeby montowania zamka, więc szyld krótki jest tu tym lepszym rozwiązaniem, które zajmuje mało miejsca. Warto również zaznaczyć, że producenci do takich modeli posiadają zazwyczaj szerszą ofertę jeśli chodzi o wzory klamek. Przykładem są kryształowe gałko-gałki, które są wyjątkowymi modelami dekorującymi przestrzeń pomieszczenia. Podobnie jak w szyldach dzielonych, dolne części szyldów krótkich dzielą się na rodzaje z otworem na klucz, z otworem na wkładkę bębnową (zamek) oraz z blokadą WC. Rzadziej spotykanymi są szyldy dolne bez przebicia.

OZNACZENIA TYPÓW SZYLDÓW

W zależności od pomieszczenia, do którego prowadzą drzwi należy użyć odpowiedniego szyldu klamkowego. W ofercie jest pięć typów, szyld dzielony, szyld długi pełny, szyld WC, szyld na klucz i szyld typu wkładka.



STYLE KLAMEK

JAKIE WZORY WYBIERAĆ DO SWOICH WNĘTRZ?

Nowoczesne, rustykalne, małe i duże, o ostrych i okrągłych kształtach... Wzorów klamek jest obecnie co niemiara. Producenci, starając się odpowiadać na wyszukane gusta klientów, wprowadzają na rynek coraz bardziej zróżnicowane serie. Jak się wśród nich odnaleźć? Jak wybrać klamkę idealną pod kątem stylistyki?

WYKOŃCZENIA

Klamki stalowe, żaluzne czy aluminiowe wykańczane są na kilka sposobów. Najczęściej spotykane z nich to niklowanie, chromowanie, lakierowanie proszkowe, patynowanie, mosiądzowanie. Powłoki te dostępne są w wersjach matowych i błyszczących. Trwałość każdej z nich jest niemal identyczna, wybór zależy więc od indywidualnego gustu i dopasowania do wnętrza.

KOLORY

Kolor klamki powinien być dobrany do kolorystyki drzwi, ale też barw obecnych w samym wnętrzu. Zwróćmy też uwagę na wykończenie okuć i zawiasów – mimo, że to elementy na co dzień mało widoczne, to jeśli nie będą współgrały z klamkami, stworzy się z nich nieciekawy zestaw. Ci, którzy preferują stonowane, subtelne aranżacje, mogą wybrać omawiany produkt tak, by nie wyróżniał się on odcieniem od skrzydła drzwiowego. Gdy styl

wnętrza jest bardziej odważny, wtedy z kolei można wybrać klamki w intensywnych czy wręcz jaskrawych barwach. W sprzedaży są też modele, które łączą w sobie różne kolory i faktury (np. chromowo-satynowe klamki PRIMA).

Poniżej zostały przedstawione wszystkie dostępne wykończenia:



KSZTAŁTY RĘKOJEŚCI

Rękojeść klamki wyróżnia nie tylko kolor, ale i kształt. Ciekawą, asymetryczną formę mają np. rękojeści w modelach DONA, zaś ukształtowanie w łagodną linię fali wyróżnia klamki MALTA. W produktach z serii RETRO, STILO czy BARON spotkamy natomiast rękojeści nawiązujące do stylu rustykalnego – fantazyjnie wygięte i oryginalnie zdobione.

ELEMENTY DEKORACYJNE

W klamkach montowane są różnorodne elementy dekoracyjne wykonane z kryształu, szkła czy tworzyw sztucznych. Na uwagę zasługują np. gałko-gałki Kuchinox, których kryształowe rękojeści są utrzymane w kolorze czarnym czy transparentnym białym i różowym, czy klamki GLORIA mające wtopione w rękojeść 9 małych kryształów.

Kolejne rozwiązanie przykuwające wzrok wykorzystano np. w klamkach ELIKA i TARA. W ich frontowej części umieszczono szklane elementy w kolorze białym lub czarnym.



Klamka z serii TARA

CZY WIESZ, ŻE...

Drzwi, a więc też klamki i zamki, dzielimy na lewe i prawe. Stań przed drzwiami tak, jakbyś chciał wejść do środka pomieszczenia. Jeśli zawias będziesz miał po lewej stronie – posiadasz drzwi lewe, jeśli po prawej – prawe.

DRZWI LEWE

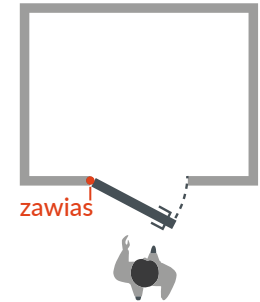
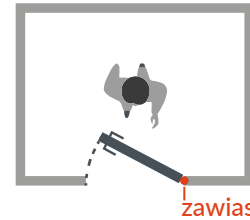

DRZWI PRAWY

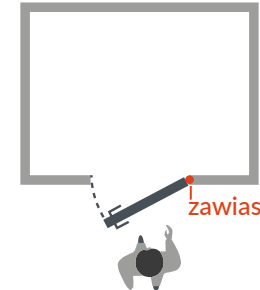
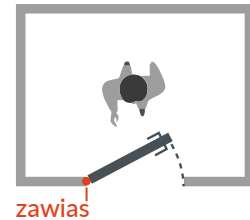

STYLE ARANŻACJI WNĘTRZ I KLAMKI DO NICH PASUJĄCE

STYL GLAMOUR

Glamour to styl, którego powstanie datuje się na początek XX wieku. Zrodził się on jako opozycja do królującego wcześniej minimalizmu. Cechuje go przede wszystkim ponadczasowy szyk, ekskluzywność, dekoracyjność i łączenie inspiracji pochodzących z różnych typów aranżacji. W klimacie glamour wszystko musi się błyszczeć, dlatego też polecamy klamki GLORIA z 9 kryształami w kolorze czarnym bądź transparentnym białym. Dobrym wyborem będą też wyjątkowe, kryształowe gałko-gałki (czarne, transparentne, różowe).

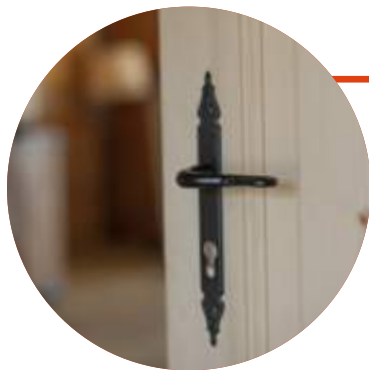

STYL RETRO

Mieszkanie z czasów babci czy prababci, z lekkim powiewem nowoczesności – tak moglibyśmy w skrócie określić styl retro. Tu sprawdzi się wszystko, co nawiązuje do stylistyki sprzed kilkudziesięciu lat – obrazy w złotych ramach, zegary z kukułką, ciężkie zasłony, drewniane i tapicerowane masywne meble, klasyczny parkiet na podłodze. W takie wnętrze idealnie wkomponują się klamki RETRO i STILO (fantazyjnie odlane, w kolorze antycznego mosiądzu), a także nieco prostsze w formie RODOS.

STYL LOFT

Lofty to postindustrialne wnętrza, których historia sięga już około 1900 roku. Wszystko zaczęło się w Paryżu, gdzie tamtejsza bohema wykorzystywała stare fabryki i magazyny na pracownie. Mieszkanie w loftach stało się popularne w latach '60 XX wieku i od tego czasu kojarzone jest z codzienną wygodą, indywidualizmem i twórczą swobodą. Lofty wyróżniają przede wszystkim naturalne, surowe struktury, otwarte przestrzenie i przemysłowy minimalizm. Dobierając do nich klamki, warto przyrzeć się takim modelom jak SILANA na rozecie, VERDON na rozecie czy QUBIK.



STYL SKANDYNAWSKI

Minimalistyczne i bardzo funkcjonalne rozwiązania, naturalne surowce i jasne kolory – za to m.in. doceniany jest styl skandynawski. Materiały wykorzystywane w takim wnętrzu to przede wszystkim surowe drewno, len, bawełna i wełna. Barwy utrzymuje się w odcieniach bieli, niebieskiego, błękitu, butelkowej zieleni oraz kontrastujących z nimi czerni oraz szarości. Należy pamiętać także o jak największej ilości naturalnego oświetlenia. Klamki, które warto wziąć pod uwagę urządzając skandynawskie wnętrza, to m.in. satynowe, matowe modele IRYS i ASTER, białe lub czarne QUBIK II oraz MEDA.

STYL MARYNISTYCZNY

Styl marynistyczny to wszystko to, co kojarzy się z latem nad morzem. Szum błękitnej wody, łagodne linie fal, białe chmury... Dlatego też marynistyczne wnętrza to właśnie biało-niebieskie kolory i wszystko to, co ma łagodne faliste linie, takie jak spotkamy w klamkach NOA, MALTA czy TALIA.

POZNAJ LINIE KLAMEK KUCHINOX

Oferta klamek marki Kuchinox podzielona jest na 3 linie: Economy, Classic i Premium. Co kryje się pod tymi nazwami? Jakie cechy wyróżniają poszczególne z nich?

ECONOMY LINE

Klamki Kuchinox Economy Line to przede wszystkim prosta i funkcjonalna forma. Dzięki temu są one bardzo uniwersalne i pasują do niemal każdego wnętrza i rodzaju drzwi. Równie ważna jest tu też dobra cena, przy jednocześnie satysfakcjonującej jakości. Do modeli Economy zaliczamy m.in. klamki ADA, AGRA czy EWA.

CLASSIC LINE

Linia Classic to klasyczna elegancja. Modele, które trafiają pod ten szyld, mają delikatną, stonowaną stylistykę, ale też urozmaiconą kolorystykę. Łatwo je dopasować do różnych typów aranżacji, doceniane są też za swoją ergonomię. Do modeli Classic zaliczamy m.in. klamki ARIA, ASTER, IRYS czy GOA.

PREMIUM LINE

Linia Premium to coś dla tych, którzy kochają niepowtarzalny design. Różnorodność wykorzystanych materiałów, bardzo szeroka gama wykończeń, efektowne wzory i polskie projekty to tylko niektóre z cech, za które doceniane są te modele. Podkreślić trzeba też innowacyjne rozwiązania montażowe. Dzięki temu wszystkiemu produkty Premium zaspokajają najbardziej wyrafinowane gusta i gwarantują najwyższy komfort użytkowania. Do modeli Premium zaliczamy m.in. klamki NERO, PARVA, ROY czy TIMOR.

Wszystkie nasze klamki są produktami wysokiej jakości. Rozróżnienie wynika z zakresu dodatkowych funkcji czy rozwiązań technologicznych.

W katalogu oznaczenie klasy serii zostało przedstawione piktogramami:



DODATKOWE OZNACZENIA INFORMACYJNE

Dla wygody przeglądania katalogu umieściliśmy piktogramy informujące o szczególnych cechach produktu. Korzystanie z nich jest prostsze niż ze standardowych opisów.



Polski projekt



Ciekawy wzór



Łatwy montaż



Szablon montażowy w komplecie



Kompaktowy wymiar



Wydłużony gwint



Gwarancja powierzchnia mechanizm



Gwarancja powierzchnia mechanizm



Klamka z serii SAVIO

KUCHINOX
INSPIRACJA PŁYNNIE Z WNĘTRZA

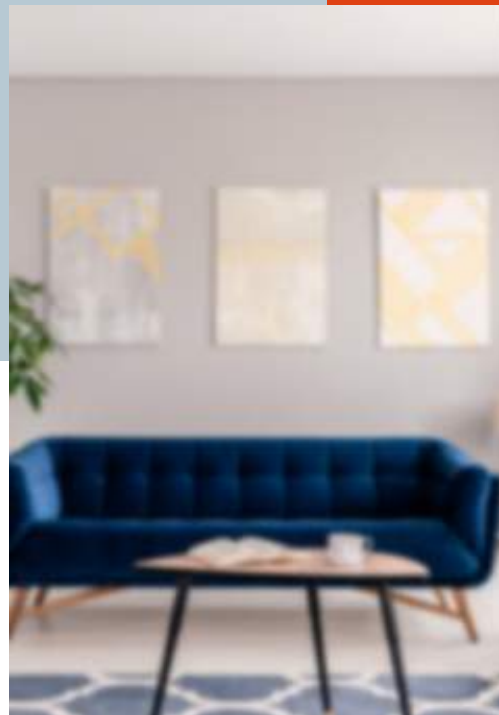

**KLAMKI
NA SZYLDZIE
DZIELONYM**



ARIA II

Klamka na szyldzie dzielonym kwadratowym



Łatwy montaż



Szablon montażowy w komplecie



Kompaktowy wymiar



Wykonane z aluminium



Gwarancja powierzchni mechanizm



KA2_100A



satyna / chrom
EAN: 5907791124272



klucz
LK4_101S



wkładka
LK4_102S



wc
LK4_103S



KA2_400A



patyna
EAN: 5907791124869



klucz
LK4_401S



wkładka
LK4_402S



wc
LK4_403S



GLORIA

Klamka na szyldzie dzielonym kwadratowym



Ciekawy wzór



Kompaktowy wymiar



Wykonane ze żalu



Gwarancja powierzchni mechanizm



KLO_000A



chrom
EAN: 5907791113498



klucz
LK2_001B



wkładka
LK2_002B



wc
LK2_003B



KLO_000B



chrom
EAN: 5907791115157



klucz
LK2_001B



wkładka
LK2_002B



wc
LK2_003B

NOWOŚĆ



KLO_900A



czarny
EAN: 5907791184238



klucz
LK2_901A



wkładka
LK2_902A



wc
LK2_903A



Klamka z serii Gloria



LUGA

Klamka na szyldzie dzielnym kwadratowym



Łatwy montaż



Szablon montażowy w komplecie



Kompaktowy wymiar



Wykonane z aluminium



Gwarancja powierzchnia mechanizm



KSL_100A



satyna / chrom

EAN: 5907791115898



klucz

LK4_101S



wkładka

LK4_102S



wc

LK4_103S



LUXOR II

Klamka na szyldzie dzielnym kwadratowym



Łatwy montaż



Szablon montażowy w komplecie



Kompaktowy wymiar



Wykonane z aluminium



Gwarancja powierzchnia mechanizm



KL2_100A



satyna / chrom

EAN: 5907791124289



klucz

LK4_101S



wkładka

LK4_102S



wc

LK4_103S



Łatwy montaż



Szablon montażowy w komplecie



Kompaktowy wymiar



Wykonane z aluminium



Gwarancja powierzchni mechanizm



KGD_100A



satyna / chrom
EAN: 5906775348338



klucz
LK4_101S



wkładka
LK4_102S



wc
LK4_103S



KGD_400A



patyna
EAN: 5906775348383



klucz
LK4_401S



wkładka
LK4_402S



wc
LK4_403S



KGD_500A



grafit / chrom
EAN: 5907791125095



klucz
LK4_501A



wkładka
LK4_502A



wc
LK4_503A



NERO

Klamka na szyldzie dzielonym
kwadratowym



Polski
projekt



Ciekawy
wzór



Łatwy
montaż



Szablon
montażowy
w komplecie



Wykonane
z aluminium



Gwarancja
powierzchnia
mechanizm



KNE_300A



satyna
EAN: 5907791123596



klucz
LK5_301A



wkładka
LK5_302A



wc
LK5_303A



KNE_500A



grafit / chrom
EAN: 5907791124210



klucz
LK5_501A



wkładka
LK5_502A



wc
LK5_503A



Klamka z serii Nero

PARVA

Klamka na sztyldzie dzielnym kwadratowym



Polski projekt



Ciekawy wzór



Łatwy montaż



Szablon montażowy w komplecie



Wykonane z aluminium



Gwarancja powierzchnia mechanizm



Klamka z serii Parva



KRV_000A



chrom
EAN: 5907791124227



klucz
LK5_001A



wkładka
LK5_002A



wc
LK5_003A



KRV_100A



satyna / chrom
EAN: 5907791122155



klucz
LK2_001B



wkładka
LK2_002B



wc
LK2_003B



PARVA

Klamka na szyldzie dzielnym kwadratowym



Polski projekt



Ciekawy wzór



Łatwy montaż



Szablon montażowy w komplecie



Wykonane z aluminium



Gwarancja powierzchnia mechanizm



KRV_300A



satyna
EAN: 5907791141347



klucz
LK5_301A



wkładka
LK5_302A



wc
LK5_303A



KRV_900A



czarny
EAN: 5907791105233



klucz
LK5_901A



wkładka
LK5_902A



wc
LK5_903A



Klamka z serii Parva

PRIMA

Klamka na szyldzie dzielnym kwadratowym



Polski projekt



Ciekawy wzór



Wykonane z aluminium



Gwarancja powierzchni mechanizm



Klamka z serii Prima



KPR_100A



satyna / chrom
EAN: 5907791132529



klucz
LK2_101B



wkładka
LK2_102B



wc
LK2_103B



QUBIK II

Klamka na szyldzie dzielnym kwadratowym



Łatwy montaż



Szablon montażowy w komplecie



Kompaktowy wymiar



Wykonane z aluminium



Gwarancja powierzchni mechanizm



KG2_300A



satyna
EAN: 5907791127792



klucz
LK5_301A



wkładka
LK5_302A



wc
LK5_303A



KG2_600A



biały
EAN: 5907791104212



klucz
LK5_601A



wkładka
LK5_602A



wc
LK5_603A



KG2_800A



różowe złoto
EAN: 5907791182128



klucz
LK5_801A



wkładka
LK5_802A



wc
LK5_803A



KG2_900A



czarny
EAN: 5907791104298



klucz
LK5_901A



wkładka
LK5_902A



wc
LK5_903A



NOWOŚĆ

KG2_G00A



złoty
EAN: 5907791182135



klucz
LK5_G01A



wkładka
LK5_G02A



wc
LK5_G03A

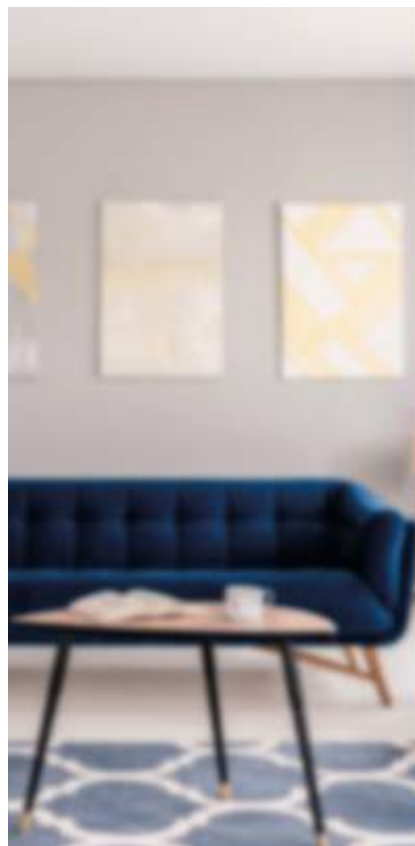

Klamka z serii Qubik II



ROY

Klamka na szyldzie dzielonym kwadratowym



Polski projekt



Ciekawy wzór



Łatwy montaż



Szablon montażowy w komplecie



Wykonane z aluminium



Gwarancja powierzchnia mechanizm



KRO_100A



satyna / chrom
EAN: 5907791123619



klucz
LK5_101A



wkładka
LK5_102A



wc
LK5_103A



Klamka z serii Roy

Klamka na szyldzie dzielnym kwadratowym



Polski projekt



Ciekawy wzór



Łatwy montaż



Szablon montażowy w komplecie



Wykonane ze stali



Gwarancja powierzchni mechanizm



Klamka z serii Savio



KSO_00B



chrom / czarne
EAN: 5907791140227



klucz
LK5_001A



wkładka
LK5_002A



wc
LK5_003A



KSO_30B



satyna / czarne
EAN: 5907791140241



klucz
LK5_301A



wkładka
LK5_302A



wc
LK5_303A



SAVIO

Klamka na szyldzie dzielnym kwadratowym



Polski projekt



Ciekawy wzór



Łatwy montaż



Szablon montażowy w komplecie



Wykonane ze Zn+Al
Zinc + Aluminium



Gwarancja powierzchni mechanizm 2/5 LATA



KSO_000W



chrom / białe
EAN: 5907791140210



klucz
LK5_001A



wkładka
LK5_002A



wc
LK5_003A



KSO_300W



satyna / białe
EAN: 5907791140234



klucz
LK5_301A



wkładka
LK5_302A



wc
LK5_303A



Klamka z serii Savio



Klamka z serii Silana



Ciekawy wzór



Wykonane ze złału



Gwarancja powierzchni mechanizm

NOWOŚĆ



KSI_300A

satyna
EAN: 5907791183330



klucz
LK1_301S



wkładka
LK1_302S



wc
LK1_303S

NOWOŚĆ



KSI_900A

czarny
EAN: 5907791183347



klucz
LK1_901A



wkładka
LK1_902A



wc
LK1_903A



TALIA

Klamka na szyldzie dzielonym kwadratowym



Łatwy montaż



Szablon montażowy w komplecie



Kompaktowy wymiar



Wykonane z aluminium



Gwarancja powierzchnia mechanizm



KWT_100S



satyna / chrom
EAN: 5907791112514



klucz
LK4_101S



wkładka
LK4_102S



wc
LK4_103S



TIMOR

Klamka na szyldzie dzielonym kwadratowym



Łatwy montaż



Szablon montażowy w komplecie



Kompaktowy wymiar



Wykonane z aluminium



Gwarancja powierzchnia mechanizm



KMT_100A



satyna / chrom
EAN: 5907791112530



klucz
LK4_101S



wkładka
LK4_102S



wc
LK4_103S

Klamka na szyldzie dzielnym kwadratowym



Ciekawy wzór



Szablon montażowy w komplecie



Kompaktywy wymiar



Wykonane z aluminium



Gwarancja powierzchnia mechanizm



Klamka z serii Areus

NOWOŚĆ



KRE_300A

● satyna
EAN: 5907791188526



klucz
LK1_301S



wkładka
LK1_302S



wc
LK1_303S

NOWOŚĆ



KRE_900A

● czarny
EAN: 5907791188533



klucz
LK1_901A



wkładka
LK1_902A



wc
LK1_903A



BINGO

Klamka na szyldzie dzielonym kwadratowym



Kompaktowy wymiar



Wykonane z aluminium



Gwarancja powierzchnia mechanizm



KGB_300A



satyna
EAN: 5906775346839



klucz
LK1_301S



wkładka
LK1_302S



wc
LK1_303S



IWA

Klamka na szyldzie dzielonym kwadratowym



Polski projekt



Ciekawy wzór



Kompaktowy wymiar



Wykonane z aluminium



Gwarancja powierzchnia mechanizm



KWA_400A



patyna
EAN: 5907791125194



klucz
LK2_401B



wkładka
LK2_402B



wc
LK2_403B

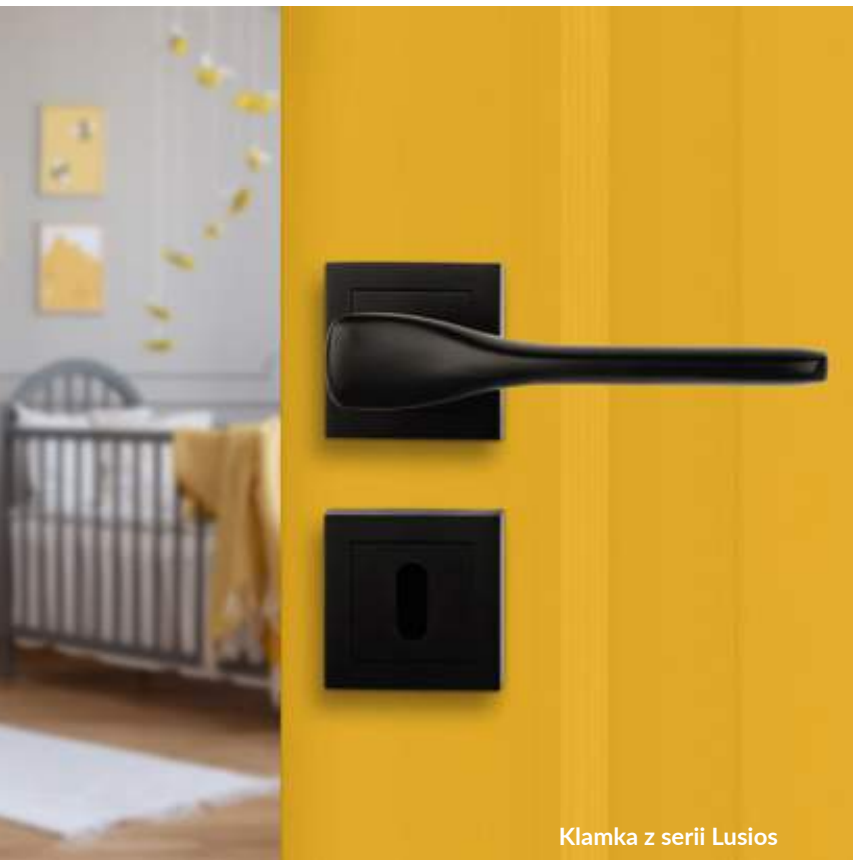

Klamka z serii Lusios



Ciekawy wzór



Kompaktywy wymiar



Wykonane z aluminium



Gwarancja powierzchni mechanizm

NOWOŚĆ



KLS_300A



satyna
EAN: 5907791188069



klucz
LK2_301B



wkładka
LK2_302B



wc
LK2_303B

NOWOŚĆ



KLS_900A



czarny
EAN: 5907791188076



klucz
LK2_901A



wkładka
LK2_902A



wc
LK2_903A



QUBIK

Klamka na szyldzie dzielonym kwadratowym



Kompaktowy wymiar



Wykonane z aluminium



Gwarancja powierzchni mechanizm



KGQ_300A



satyna
EAN: 5907791110169



klucz
LK1_301S



wkładka
LK1_302S



wc
LK1_303S



KGQ_400A



patyna
EAN: 5907791111616



klucz
LK1_401S



wkładka
LK1_402S



wc
LK1_403S



RANDO

Klamka na szyldzie dzielonym kwadratowym



Kompaktowy wymiar



Wykonane z aluminium



Gwarancja powierzchni mechanizm



KRA_900A



czarny
EAN: 5907791141910



klucz
LK2_901A



wkładka
LK2_902A



wc
LK2_903A



Kompaktywy wymiar



Wykonane z aluminium



Gwarancja powierzchni mechanizm



Klamka z serii Samaria

NOWOŚĆ



klucz
LK2_301B



wkładka
LK2_302B



wc
LK2_303B

KAM_300A



satyna
EAN: 5907791188083

NOWOŚĆ



klucz
LK2_901A



wkładka
LK2_902A



wc
LK2_903A

KAM_900A



czarny
EAN: 5907791188090



VERA

Klamka na szyldzie dzielonym kwadratowym



Kompaktowy wymiar



Wykonane z aluminium



Gwarancja powierzchni mechanizm



KVE_900A



czarny
EAN: 5907791158963



klucz
LK1_901A



wkładka
LK1_902A



wc
LK1_903A



ELIKA

Klamka na szyldzie dzielonym okrągłym



Ciekawy wzór



Wykonane ze żnalu



Gwarancja powierzchni mechanizm



KAE_600A



chrom / biały
EAN: 5907791105356



klucz
LO1_001S



wkładka
LO1_002S



wc
LO1_003S



KAE_800W



różowe złoto / biały
EAN: 5907791182159



klucz
LO1_801A



wkładka
LO1_802A



wc
LO1_803A

nowość



KAE_800B

 różowe złoto / czarny
EAN: 5907791182142

NOWOŚĆ



klucz
LO1_801A



wkładka
LO1_802A



wc
LO1_803A



KAE_900A

 chrom / czarny
EAN: 5907791105691



klucz
LO1_001S



wkładka
LO1_002S



wc
LO1_003S



Klamka z serii Elika



ELIKA

Klamka na szyldzie dzielnym okrągłym



Ciekawy wzór



Kompaktowy wymiar



Wykonane ze znułu



Gwarancja powierzchni mechanizm



NOWOŚĆ

KAE_G00B



złoty / czarny
EAN: 5907791182166



klucz
LO1_G01A



wkładka
LO1_G02A



wc
LO1_G03A



NOWOŚĆ

KAE_G00W



złoty / biały
EAN: 5907791182173



klucz
LO1_G01A



wkładka
LO1_G02A



wc
LO1_G03A



GAŁKI KRYSTAŁOWE

Gałko-gałka kryształowa na szyldzie dzielnym okrągłym



Ciekawy wzór



Łatwy montaż



Wydłużony gwint



Wykonane ze znułu



Gwarancja powierzchni mechanizm



KTK_090A



chrom
EAN: 5907791128799



klucz
LO1_001S



wkładka
LO1_002S



wc
LO1_003S



KTK_09NP



chrom
EAN: 5907791144829



klucz
LO1_001S



wkładka
LO1_002S



wc
LO1_003S



KTK_09NB



chrom
EAN: 5907791144812



KTK_39NA



satyna
EAN: 5907791144836



klucz
LO1_001S



wkładka
LO1_002S



wc
LO1_003S



klucz
LO1_301S



wkładka
LO1_302S



wc
LO1_303S



Gałka kryształowa





TARA

Klamka na szyldzie dzielonym okrągłym



Ciekawy wzór



Wykonane ze stali



Gwarancja powierzchni mechanizm



KAT_600A



chrom / biały
EAN: 5907791105332



klucz
LO1_001S



wkładka
LO1_002S



wc
LO1_003S



KAT_900A



chrom / czarny
EAN: 5907791105684



klucz
LO1_001S



wkładka
LO1_002S



wc
LO1_003S



Klamka z serii Tara



Ciekawy wzór



Kompaktowy wymiar



Wykonane z aluminium



Gwarancja powierzchni mechanizm



Klamka z serii Verdon

NOWOŚĆ



klucz
LO1_3M1A



wkładka
LO1_3M2A



wc
LO1_3M3A

KVR_3M0A



satyna mat
EAN: 5907791187291

NOWOŚĆ



klucz
LO1_921A



wkładka
LO1_922A



wc
LO1_923A

KVR_900A



czarny
EAN: 5907791187284



ANDA

Klamka na szyldzie dzielonym okrągłym



Polski projekt



Ciekawy wzór



Kompaktowy wymiar



Wykonane z aluminium



Gwarancja powierzchni mechanizm



KAN_300A



satyna
EAN: 5907791141323



klucz
LO1_301S



wkładka
LO1_302S



wc
LO1_303S



ARIA

Klamka na szyldzie dzielonym okrągłym



Kompaktowy wymiar



Wykonane z aluminium



Gwarancja powierzchni mechanizm



KAR_300A



satyna
EAN: 5907791132437



klucz
LO1_301S



wkładka
LO1_302S



wc
LO1_303S



KAR_400A



patyna
EAN: 5907791132475



klucz
LO1_401S



wkładka
LO1_402S



wc
LO1_403S

ASTER

Klamka na szyldzie dzielnym okrągłym



Kompaktowy wymiar



Wykonane z aluminium



Gwarancja powierzchnia mechanizm



KAS_3M0A



satyna mat
EAN: 5907791124593



klucz
LO1_3M1S



wkładka
LO1_3M2S



wc
LO1_3M3S



KAS_4M0A



patyna mat
EAN: 5907791124630



klucz
LO1_4M1A



wkładka
LO1_4M2A



wc
LO1_4M3A

AURA

Klamka na szyldzie dzielnym okrągłym



Kompaktowy wymiar



Wykonane z aluminium



Gwarancja powierzchnia mechanizm



KSA_300A



satyna
EAN: 5906775346549



klucz
LO1_301S



wkładka
LO1_302S



wc
LO1_303S



DONA

Klamka na szyldzie dzielonym
okrągłym



Ciekawy
wzór



Kompaktowy
wymiar



Wykonane
z aluminium



Gwarancja
powierzchnia
mechanizm



KDO_300A



satyna
EAN: 5907791123435



klucz
LO1_301S



wkładka
LO1_302S



wc
LO1_303S



DUET

Klamka na szyldzie dzielonym
okrągłym



Polski
projekt



Ciekawy
wzór



Kompaktowy
wymiar



Wykonane
z aluminium



Gwarancja
powierzchnia
mechanizm



KDU_100A



satyna / chrom
EAN: 5907791130136



klucz
LO1_101S



wkładka
LO1_102S



wc
LO1_103S

GEMELA

Klamka na szyldzie dzielnym okrągłym



Kompaktowy wymiar



Wykonane z aluminium



Gwarancja powierzchni mechanizm



KEM_100A



satyna / chrom
EAN: 5907791130143



klucz
LO1_101S



wkładka
LO1_102S



wc
LO1_103S

GOA

Klamka na szyldzie dzielnym okrągłym



Kompaktowy wymiar



Wykonane z aluminium



Gwarancja powierzchni mechanizm



KCG_300A



satyna
EAN: 5907791111333



klucz
LO1_301S



wkładka
LO1_302S



wc
LO1_303S



KCG_400A



patyna
EAN: 5907791111388



klucz
LO1_401S



wkładka
LO1_402S



wc
LO1_403S



IRYS

Klamka na szyldzie dzielnym okrągłym



Ciekawy wzór



Kompaktowy wymiar



Wykonane z aluminium



Gwarancja powierzchnia mechanizm



KCI_3M0A



satyna mat

EAN: 5907791110060



klucz
LO1_3M1S



wkładka
LO1_3M2S



wc
LO1_3M3S



LUGA II

Klamka na szyldzie dzielnym okrągłym



Kompaktowy wymiar



Wykonane z aluminium



Gwarancja powierzchnia mechanizm



nowość

KS2_900A



czarny

EAN: 5907791188540



klucz
LO1_911A



wkładka
LO1_912A



wc
LO1_913A

LUXOR

Klamka na szyldzie dzielnym okrągłym



Kompaktowy wymiar



Wykonane z aluminium



Gwarancja powierzchnia mechanizm



KLU_100A



satyna / chrom
EAN: 5907791139016



klucz
LO1_101S



wkładka
LO1_102S



wc
LO1_103S

MALTA

Klamka na szyldzie dzielnym okrągłym



Kompaktowy wymiar



Wykonane z aluminium



Gwarancja powierzchnia mechanizm



KLM_3M0A



satyna mat
EAN: 5907791110176



klucz
LO1_3M1S



wkładka
LO1_3M2S



wc
LO1_3M3S



KLM_400A



patyna
EAN: 5907791110220



klucz
LO1_401S



wkładka
LO1_402S



wc
LO1_403S



MARIO

Klamka na szyldzie dzielnym okrągłym



Kompaktowy wymiar



Wykonane z aluminium



Gwarancja powierzchni mechanizm



KSM_300S



satyna
EAN: 5907791111814



klucz
LO2_301S



wkładka
LO2_302S



wc
LO2_303S



KSM_400S



patyna
EAN: 5907791111869



klucz
LO2_401S



wkładka
LO2_402S



wc
LO2_403S



MARS

Klamka na szyldzie dzielnym okrągłym



Kompaktowy wymiar



Wykonane z aluminium



Gwarancja powierzchni mechanizm



KCM_100A



satyna / chrom
EAN: 5906775344651



klucz
LO1_101S



wkładka
LO1_102S



wc
LO1_103S



Ciekawy wzór



Kompaktowy wymiar



Wykonane z aluminium



Gwarancja powierzchnia mechanizm



KCR_390A



satyna
EAN: 5906775348567



klucz
LO2_301S



wkładka
LO2_302S



wc
LO2_303S



KCR_400A



patyna
EAN: 5906775344842



klucz
LO2_401S



wkładka
LO2_402S



wc
LO2_403S



KCR_490A



patyna
EAN: 5906775348550



klucz
LO2_401S



wkładka
LO2_402S



wc
LO2_403S



RODOS

Klamka i gałka na szyldzie dzielnym okrągłym



Kompaktowy wymiar



Wykonane z aluminium



Gwarancja powierzchnia mechanizm



KGO_400A



patyna
EAN: 5906775348628



klucz
LO2_401S



wkładka
LO2_402S



wc
LO2_403S



STILO

Klamka na szyldzie dzielnym okrągłym



Kompaktowy wymiar



Wykonane z aluminium



Gwarancja powierzchnia mechanizm



KCS_400A



patyna
EAN: 5906775347218



klucz
LO2_401S



wkładka
LO2_402S



wc
LO2_403S

ADA

Klamka na szyldzie dzielnym okrągłym



Kompaktowy wymiar



Wykonane z aluminium



Gwarancja powierzchnia mechanizm



KAD_300A



satyna
EAN: 5907791113405



klucz
LO1_301S



wkładka
LO1_302S



wc
LO1_303S

AGRA

Klamka na szyldzie dzielnym okrągłym



Kompaktowy wymiar



Wykonane z aluminium



Gwarancja powierzchnia mechanizm



KAG_300A



satyna
EAN: 5907791122889



klucz
LO1_301S



wkładka
LO1_302S



wc
LO1_303S



KAG_400A



patyna
EAN: 5907791126245



klucz
LO1_401S



wkładka
LO1_402S



wc
LO1_403S



EWA

Klamka na szyldzie dzielonym okrągłym



Kompaktywy wymiar



Wykonane z aluminium



Gwarancja powierzchni mechanizm



KEW_300A



satyna
EAN: 5907791123473



klucz
LO3_301A



wkładka
LO3_302A



wc
LO3_303A



NOA

Klamka na szyldzie dzielonym okrągłym



Kompaktywy wymiar



Wykonane z aluminium



Gwarancja powierzchni mechanizm



KNA_300A



satyna
EAN: 5907791112576



klucz
LO1_301S



wkładka
LO1_302S



wc
LO1_303S



KNA_400A



patyna
EAN: 5907791112897



klucz
LO1_401S



wkładka
LO1_402S



wc
LO1_403S

STANDARD

Klamka na szyldzie dzielonym
okrągłym



Kompaktowy
wymiar



Wykonane
z aluminium



Gwarancja
powierzchnia
mechanizm



klucz
LO1_301S



wkładka
LO1_302S



wc
LO1_303S

KST_300A



satyna
EAN: 5907791124784

KUCHINOX
INSPIRACJA PŁYNIE Z WNĘTRZA



**KLAMKI
ZE STALI
NIERDZEWNEJ**



FARO

Klamka ze stali nierdzewnej



Łatwy montaż



Kompaktowy wymiar



Wydłużony gwint



Wykonane ze stali nierdzewnej



Gwarancja powierzchnia mechanizm



KGF_200A

stal nierdzewna
EAN: 5906775344798



klucz
LO1_201S



wkładka
LO1_202S



wc
LO1_203S



KGF_900A

czarny
EAN: 5907791165404



klucz
LO1_901A



wkładka
LO1_902A



wc
LO1_903A



LAGOS

Klamka ze stali nierdzewnej



Łatwy montaż



Kompaktowy wymiar



Wydłużony gwint



Wykonane ze stali nierdzewnej



Gwarancja powierzchnia mechanizm



KGL_200A

stal nierdzewna
EAN: 5906775344781



klucz
LO1_201S



wkładka
LO1_202S



wc
LO1_203S



KGL_900A

czarny
EAN: 5907791165916



klucz
LO1_901A



wkładka
LO1_902A



wc
LO1_903A



Łatwy montaż



Kompaktowy wymiar



Wydłużony gwint



Wykonane ze stali nierdzewnej



Gwarancja powierzchnia mechanizm



KGM_200A

stal nierdzewna
EAN: 5907791113115



klucz
LK2_201A



wkładka
LK2_202A



wc
LK2_203A



KGM_900A

czarny
EAN: 5907791165930



klucz
LK2_921A



wkładka
LK2_922A



wc
LK2_923A



PORTO

Klamka ze stali nierdzewnej



Łatwy montaż



Kompaktowy wymiar



Wydłużony gwint



Wykonane ze stali nierdzewnej



Gwarancja powierzchni mechanizm



klucz
LO1_201S



wkładka
LO1_202S



wc
LO1_203S

KGP_200A



stal nierdzewna
EAN: 5906775344804



Klamka ze stali nierdzewnej



ŁATWY
MONTAŻ



KOMPAKTOWY
WYMIAR



WYDŁUŻONY
GWINT



WYKONANE
ZE STALI
NIERDZEWNEJ



2/5
LATA
GWARANCJA
POWIERZCHNIA
MECHANIZM



Klamka z serii Wigo



KGW_200A



stal nierdzewna
EAN: 5907791113368



klucz
LO1_201S



wkładka
LO1_202S



wc
LO1_203S



KGW_900A



czarny
EAN: 5907791165923



klucz
LO1_901A



wkładka
LO1_902A



wc
LO1_903A

KUCHINOX
INSPIRACJA PŁYNIE Z WNĘTRZA



**KLAMKI
NA DŁUGIM
SZYLDZIE**



ADA

Klamka na szyldzie długim



Łatwy montaż



Kompaktowy wymiar



Wykonane z aluminium



Gwarancja powierzchni mechanizm



AGRA

Klamka na szyldzie długim



KAD_311A

EAN: 5907791113412



KAD_316A

EAN: 5907791118219



satyna



KAD_312A

EAN: 5907791113429



KAD_315A

EAN: 5907791118202



satyna

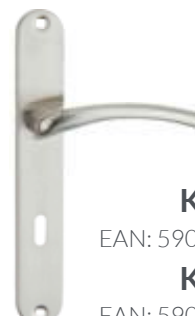

KAG_311A

EAN: 5907791122896



KAG_316A

EAN: 5907791118233



satyna



KAD_313A

EAN: 5907791113436



satyna

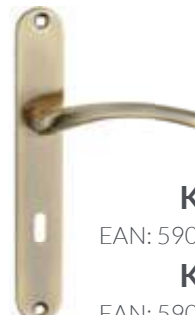

KAG_411A

EAN: 5907791126252



KAG_416A

EAN: 5907791118653



patyna



Łatwy montaż



Kompaktowy wymiar



Wykonane z aluminium



Gwarancja powierzchni mechanizm

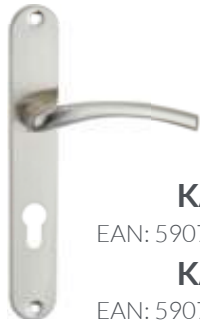

KAG_312A

EAN: 5907791122902



KAG_315A

EAN: 5907791118226



satyna

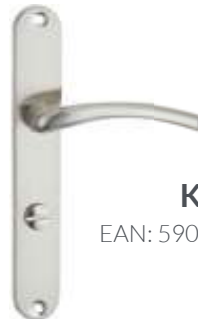

KAG_313A

EAN: 5907791122919



satyna

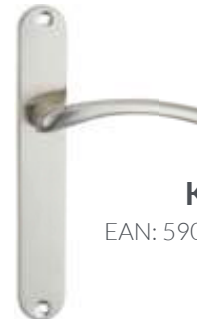

KAG_314A

EAN: 5907791126238



satyna



KAG_412A

EAN: 5907791126269



KAD_415A

EAN: 5907791118240



patyna



KAG_413A

EAN: 5907791126276



patyna



KAG_414A

EAN: 5907791126283



patyna



ARIA

Klamka na szyldzie długim



Łatwy montaż



Kompaktywy wymiar



Wykonane z aluminium



Gwarancja powierzchni mechanizm

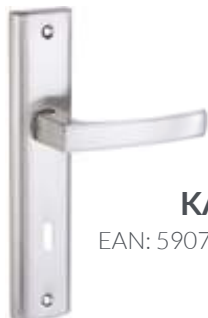

KAR_311A

EAN: 5907791132444



satyna



KAR_312A

EAN: 5907791132451



satyna

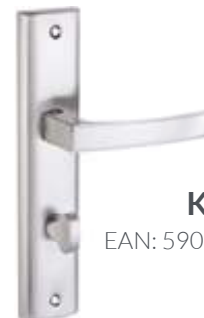

KAR_313A

EAN: 5907791132468



satyna



KAR_411A

EAN: 5907791132482



patyna



KAR_412A

EAN: 5907791132499



patyna

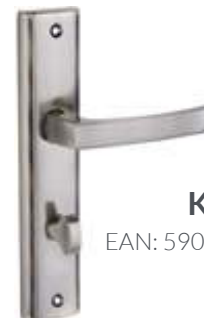

KAR_413A

EAN: 5907791132505



patyna



Łatwy montaż



Kompaktowy wymiar



Wykonane z aluminium



Gwarancja powierzchni mechanizm

ASTER

Klamka na szyldzie długim



KAS_3M1A

EAN: 5907791124609



satyna mat



KAS_3M2A

EAN: 5907791124616



satyna mat



KAS_3M3A

EAN: 5907791124623



satyna mat

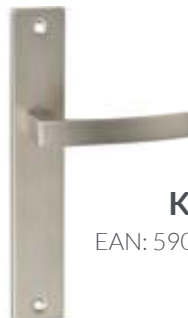

KAS_3M4A

EAN: 5907791128171



satyna mat



AURA

Klamka na szyldzie długim



Łatwy montaż



Kompakty wymiar



Wykonane z aluminium



Gwarancja powierzchnia mechanizm

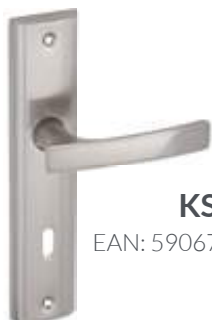

KSA_311A

EAN: 5906775346556



satyna

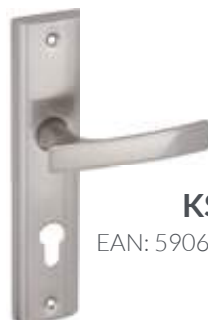

KSA_312A

EAN: 5906775346563



satyna



KSA_313A

EAN: 5906775346570



satyna



Łatwy montaż



Kompaktowy wymiar



Wykonane z aluminium



Gwarancja powierzchni mechanizm

BINGO

Klamka na szyldzie długim



KGB_311A

EAN: 5906775346846



satyna

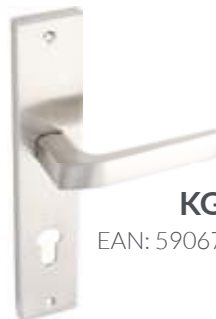

KGB_312A

EAN: 5906775346853



satyna



KGB_313A

EAN: 5906775346860



satyna



KGB_314A

EAN: 5906775346877



satyna



EWA

Klamka na szyldzie długim



Łatwy montaż



Kompaktowy wymiar



Wykonane z aluminium



Gwarancja powierzchni mechanizm



GOA

Klamka na szyldzie długim



KEW_311A

EAN: 5907791123510



KEW_316A

EAN: 5907791118875



satyna



KEW_312A

EAN: 5907791123497



satyna



KCG_311A

EAN: 5907791111340



satyna



KEW_313A

EAN: 5907791123503



satyna



KEW_314A

EAN: 5907791128225



satyna



KCG_411A

EAN: 5907791111395



patyna

KCG_316A

EAN: 5907791124012





Łatwy montaż



Kompaktowy wymiar



Wykonane z aluminium



Gwarancja powierzchni mechanizm



KCG_312A

EAN: 5907791111357



satyna



KCG_313A

EAN: 5907791111364



satyna



KCG_314A

EAN: 5907791111371



satyna



KCG_412A

EAN: 5907791111401



patyna

KCG_315A

EAN: 5907791124005



KCG_413A

EAN: 5907791111418



patyna



IRYS

Klamka na szyldzie długim



Ciekawy wzór



Łatwy montaż



Kompaktowy wymiar



Wykonane z aluminium



Gwarancja powierzchni mechanizm



KCI_3M1A

EAN: 5907791110077



satyna mat



KCI_3M2A

EAN: 5907791110084



satyna mat



KCI_3M3A

EAN: 5907791110091



satyna mat



KCI_3M4A

EAN: 5907791110107



satyna mat



Łatwy montaż



Kompaktowy wymiar



Wykonane z aluminium



Gwarancja powierzchni mechanizm

LUGA II

Klamka na szyldzie długim



NOWOŚĆ

KS2_911A

EAN: 5907791188557



czarny

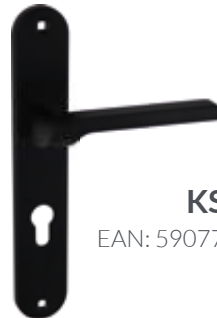

NOWOŚĆ

KS2_912A

EAN: 5907791188564



czarny

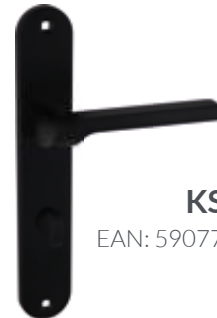

NOWOŚĆ

KS2_913A

EAN: 5907791188571



czarny



LUXOR

Klamka na szyldzie długim



Łatwy montaż



Kompaktowy wymiar



Wykonane z aluminium



Gwarancja powierzchnia mechanizm



KLU_111A

EAN: 5907791139023



KLU_116A

EAN: 5907791119087



satyna / chrom



KLU_112A

EAN: 5907791139030



KLU_115A

EAN: 5907791119063



satyna / chrom

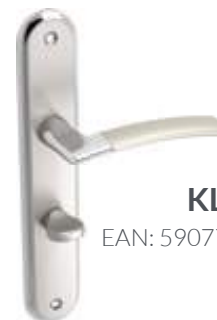

KLU_113A

EAN: 5907791139047



satyna / chrom



Łatwy montaż



Kompaktowy wymiar



Wykonane ze znu



Gwarancja powierzchni mechanizm

MADERA

Klamka na szyldzie długim



KGD_111A

EAN: 5906775348345



satyna / chrom



KGD_112A

EAN: 5906775348352



satyna / chrom



KGD_113A

EAN: 5906775348369



satyna / chrom



MALTA

Klamka na szyldzie długim



Łatwy montaż



Kompaktowy wymiar



Wykonane z aluminium



Gwarancja powierchnia mechanizm



KLM_3M1A

EAN: 5907791110183



satyna mat



KLM_3M2A

EAN: 5907791110190



satyna mat



KLM_3M3A

EAN: 5907791110206



satyna mat



Łatwy montaż



Kompaktowy wymiar



Wykonane z aluminium



Gwarancja powierzchni mechanizm

NOA

Klamka na sztyldzie długim

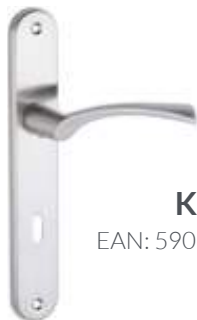

KNA_311A

EAN: 5907791112583



satyna

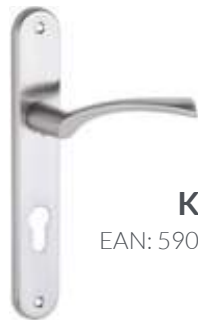

KNA_312A

EAN: 5907791112590



satyna

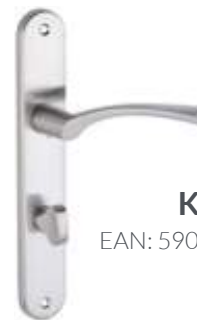

KNA_313A

EAN: 5907791112606



satyna

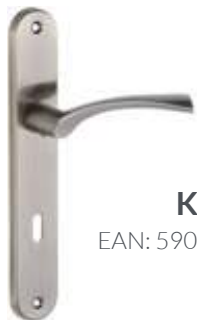

KNA_411A

EAN: 5907791112903



patyna

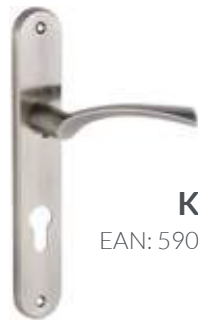

KNA_412A

EAN: 5907791112910



patyna

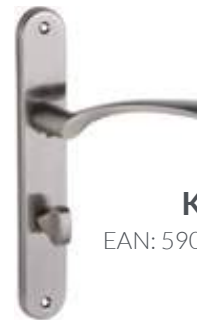

KNA_413A

EAN: 5907791112927



patyna



PARVA

Klamka na szyldzie długim



Polski projekt



Ciekawy wzór



Łatwy montaż



Wykonane z aluminium



Gwarancja powierzchni mechanizm



KRV_111A

EAN: 5907791123268



satyna / chrom



KRV_112A

EAN: 5907791123275



satyna / chrom



KRV_113A

EAN: 5907791123282



satyna / chrom



Polski projekt



Ciekawy wzór



Łatwy montaż



Wykonane z aluminium



Gwarancja powierzchni mechanizm

PRIMA

Klamka na szyldzie długim



KPR_111A

EAN: 5907791141200



satyna / chrom



KPR_112A

EAN: 5907791141217



satyna / chrom



KPR_113A

EAN: 5907791141224



satyna / chrom



KPR_114A

EAN: 5907791139641



satyna / chrom



QUBIK

Klamka na szyldzie długim



Łatwy montaż



Kompaktowy wymiar



Wykonane z aluminium



Gwarancja powierzchni mechanizm

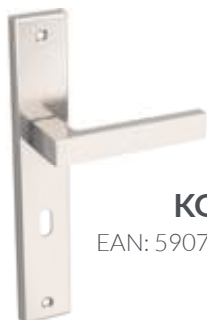

KGQ_311A

EAN: 5907791141262



satyna

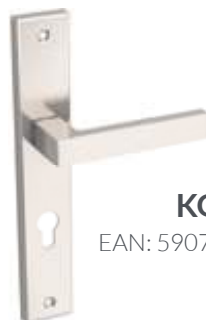

KGQ_312A

EAN: 5907791141279



satyna



KGQ_313A

EAN: 5907791141286



satyna



EASY

Łatwy montaż



Kompaktowy wymiar



Aluminium

Wykonane z aluminium



2/5 LATA

Gwarancja powierzchni mechanizm

RANDO

Klamka na szyldzie długim



KRA_911A

EAN: 5907791168719



czarny

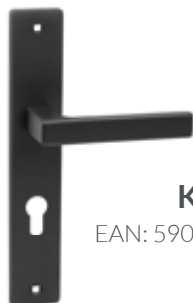

KRA_912A

EAN: 5907791168726



czarny



KRA_913A

EAN: 5907791168733



czarny



KRA_914A

EAN: 5907791168740



czarny



RETRO

Klamka na szyldzie długim



Ciekawy wzór



Łatwy montaż



Kompaktowy wymiar



Wykonane z aluminium



Gwarancja powierzchni mechanizm



KCR_411A

EAN: 5906775344903



patyna



KCR_412A

EAN: 5906775344897



patyna



KCR_413A

EAN: 5906775344910



patyna



KCR_414A

EAN: 5906775344880



patyna



lewa
KCR_432A

EAN: 5906775344972



prawa
KCR_422A

EAN: 5906775344965



patyna



Łatwy montaż



Kompaktowy wymiar



Wykonane z aluminium



Gwarancja powierzchni mechanizm

RODOS

Klamka na szyldzie długim



KGO_411A

EAN: 5906775348635



KGO_416A

EAN: 5907791119056



patyna



KGO_412A

EAN: 5906775348642



KGO_415A

EAN: 5907791119049



patyna



KGO_413A

EAN: 5906775348659



patyna



KGO_414A

EAN: 5906775348666



patyna



STILO

Klamka na szyldzie długim



Ciekawy wzór



Łatwy montaż



Kompaktowy wymiar



Wykonane z aluminium



Gwarancja powierzchni mechanizm



KCS_411A

EAN: 5906775347225



KCS_416A

EAN: 5907791118868



patyna



KCS_412A

EAN: 5906775347232



KCS_415A

EAN: 5906775347263



patyna



KCS_413A

EAN: 5906775347249



patyna

KLAMKI
ZEWNĘTRZNE



AURIS

Klamka na szyldzie długim



Łatwy montaż



Kompaktowy wymiar



Wykonane z aluminium



Gwarancja powierzchni mechanizm



FLOKO

Klamka na szyldzie długim



wkładka
LZ1_102A

KZA_112A

EAN: 5907791115423



satyna / chrom



wkładka
LZ1_4M2A

KZA_4M2A

EAN: 5907791115430



patyna mat



wkładka
LZ3_302A

KZF_312A

EAN: 5907791180599



KZF_318A

EAN: 5907791165855



anodowana satyna



wkładka
LZ3_402A

KZF_412A

EAN: 5907791165848



anodowana patyna



Łatwy
montaż



Kompaktowy
wymiar



Wykonane
z aluminium



Gwarancja
powierzchnia
mechanizm



wkładka
LZ3_302A

KZF_322A

EAN: 5907791180605



anodowana satyna



wkładka
LZ3_902A

KZF_912A

EAN: 5907791180612



KZF_918A

EAN: 5907791113801



anodowana czerni



Klamka z serii Floko



FRIDA

Klamka na szyldzie długim



Łatwy montaż



Kompaktowy wymiar



Wykonane z aluminium



Gwarancja powierzchnia mechanizm



KZC_312L

EAN: 5907791109408



satyna



KZC_312P

EAN: 5907791109415



satyna



IRMA

Klamka na szyldzie długim



Łatwy montaż



Kompaktowy wymiar



Wykonane z aluminium



Gwarancja powierzchnia mechanizm



KZI_312L

EAN: 5907791118134



satyna



KZI_312P

EAN: 5907791118141



satyna

**KLAMKI
BRAMOWE**



BARON

Klamka na szyldzie długim



Ciekawy wzór



Łatwy montaż



Kompaktowy wymiar



Wykonane z aluminium



Gwarancja powierzchni mechanizm



KGR_915A

EAN: 5907791111036



czarny



KGR_925A

EAN: 5907791141439



czarny



KGR_935A

EAN: 5907791141446



czarny



Łatwy montaż



Kompaktowy wymiar



Wykonane z aluminium



Gwarancja powierzchni mechanizm

MAGNAT

Klamka na szyldzie długim



NOWOŚĆ

KGR_515S

EAN: 5907791187369



grafit



NOWOŚĆ

KGR_535S

EAN: 5907791187376



grafit



KGR_M85S

EAN: 5907791119728



KGR_M15S

EAN: 5907791111630



KGR_M92S

EAN: 5907791119735



czarny



KGR_M35S

EAN: 5907791111623



czarny



MAGNAT

Klamka na szyldzie długim



Łatwy
montaż



Kompaktowy
wymiar



Wykonane
z aluminium



Gwarancja
powierzchnia
mechanizm



NOWOŚĆ

KGR_565S

EAN: 5907791187383



grafit



KGR_M65S

EAN: 5907791111647



czarny

SZYLDY



SZYLDY KWADRATOWE

Szyld dzielony

KLUCZ



LK1_301S



satyna
EAN: 5907791112408



LK1_401S



patyna
EAN: 5907791112439



LK1_901A



czarny
EAN: 5907791158970

WKŁADKA



LK1_302S



satyna
EAN: 5907791112415



LK1_402S



patyna
EAN: 5907791112446



LK1_902A



czarny
EAN: 5907791158987

WC



LK1_303S



satyna
EAN: 5907791112422



LK1_403S



patyna
EAN: 5907791112453



LK1_903A



czarny
EAN: 5907791158994



LK2_001B



chrom
EAN: 5907791120618



LK2_101B



satyna / chrom
EAN: 5907791139603



LK2_201A



satyna
EAN: 5907791113139



LK2_301B



satyna
EAN: 5907791126504



LK2_002B



chrom
EAN: 5907791120625



LK2_102B



satyna / chrom
EAN: 5907791139610



LK2_202A



satyna
EAN: 5907791113146



LK2_302B



satyna
EAN: 5907791126511



LK2_003B



chrom
EAN: 5907791120632



LK2_103B



satyna / chrom
EAN: 5907791139627



LK2_203A



satyna
EAN: 5907791113153



LK2_303B



satyna
EAN: 5907791126528



SZYLDY KWADRATOWE

Szyld dzielony

KLUCZ



LK2_401B



patyna
EAN: 5907791141361



LK2_501B



grafit / chrom
EAN: 5907791128324



LK2_901A



czarny
EAN: 5907791141927

WKŁADKA



LK2_402B



patyna
EAN: 5907791141378



LK2_502B



grafit / chrom
EAN: 5907791128331



LK2_902A



czarny
EAN: 5907791141934

WC



LK2_403B



patyna
EAN: 5907791141385



LK2_503B



grafit / chrom
EAN: 5907791128348



LK2_903A



czarny
EAN: 5907791141941



LK2_921A



czarny
EAN: 5907791165947



LK4_101S



satyna / chrom
EAN: 5906775348437



LK4_401S



patyna
EAN: 5906775348468



LK4_501A



grafit / chrom
EAN: 5907791125101



LK2_922A



czarny
EAN: 5907791165954



LK4_102S



satyna / chrom
EAN: 5906775348444



LK4_402S



patyna
EAN: 5906775348475



LK4_502A



grafit / chrom
EAN: 5907791125118



LK2_923A



czarny
EAN: 5907791165961



LK4_103S



satyna / chrom
EAN: 5906775348451



LK4_403S



patyna
EAN: 5906775348482



LK4_503A



grafit / chrom
EAN: 5907791125125



SZYLDY KWADRATOWE

Szyld dzielony

KLUCZ



LK5_001A



chrom
EAN: 5907791124241



LK5_101A



satyna / chrom
EAN: 5907791124098



LK5_301A



satyna
EAN: 5907791124128

WKŁADKA



LK5_002A



chrom
EAN: 5907791124258



LK5_102A



satyna / chrom
EAN: 5907791124104



LK5_302A



satyna
EAN: 5907791124135

WC



LK5_003A



chrom
EAN: 5907791124265



LK5_103A



satyna / chrom
EAN: 5907791124111



LK5_303A



satyna
EAN: 5907791124142



LK5_501A

grafit / chrom
EAN: 5907791124067



LK5_601A

biały
EAN: 5907791104236



LK5_801A

różowe złoto
EAN: 5907791188182



LK5_901A

czarny
EAN: 5907791104311



LK5_502A

grafit / chrom
EAN: 5907791124074



LK5_602A

biały
EAN: 5907791104250



LK5_802A

różowe złoto
EAN: 5907791183569



LK5_902A

czarny
EAN: 5907791104335



LK5_503A

grafit / chrom
EAN: 5907791124081



LK5_603A

biały
EAN: 5907791104274



LK5_803A

różowe złoto
EAN: 5907791188199

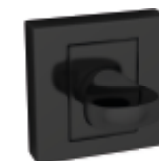

LK5_903A

czarny
EAN: 5907791104359



SZYLDY KWADRATOWE

Szyld dzielony



Gwarancja



SZYLDY OKRĄGŁE

Szyld dzielony

KLUCZ

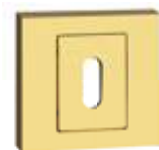

NOWOŚĆ

LK5_G01A



złoty
EAN: 5907791188168

WKŁADKA



NOWOŚĆ

LK5_G02A



złoty
EAN: 5907791183552

WC



NOWOŚĆ

LK5_G03A



złoty
EAN: 5907791188175

KLUCZ



LO1_0M1A



chrom / mat
EAN: 5907791145116

WKŁADKA



LO1_0M2A



chrom / mat
EAN: 597791145123

WC



LO1_0M3A



chrom / mat
EAN: 5907791145130



LO1_001S



chrom
EAN: 5907791110909



LO1_101S



satyna / chrom
EAN: 5907791112224



LO1_201S



satyna
EAN: 5907791113160



LO1_301S



satyna
EAN: 5907791112255



LO1_002S



chrom
EAN: 5907791110916



LO1_102S



satyna / chrom
EAN: 5907791112231



LO1_202S



satyna
EAN: 5907791113177



LO1_302S



satyna
EAN: 5907791112262



LO1_003S



chrom
EAN: 5907791110923



LO1_103S



satyna / chrom
EAN: 5907791112248



LO1_203S



satyna
EAN: 5907791113184



LO1_303S



satyna
EAN: 5907791112279



SZYLDY OKRĄGŁE

Szyld dzielony

KLUCZ

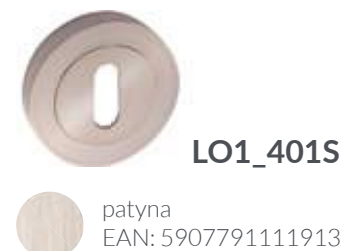
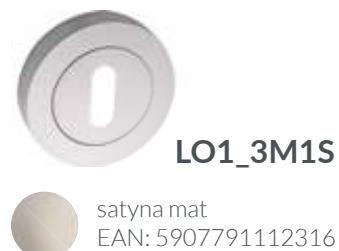

WKŁADKA

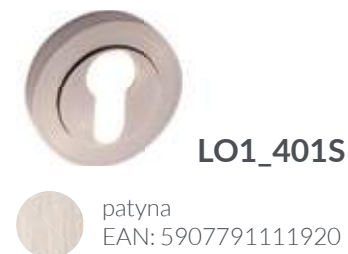
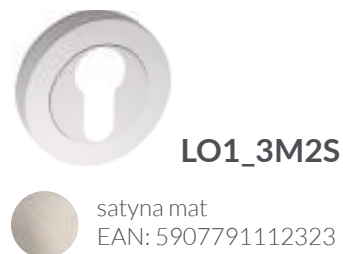

WC

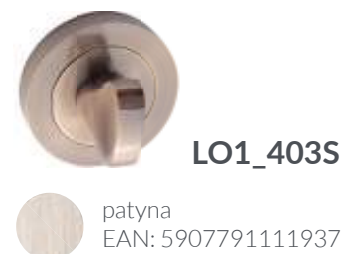
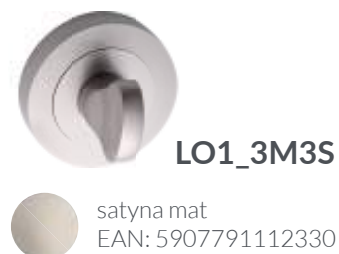



LO1_4M1A



patyna mat
EAN: 5907791122674



LO1_801A



różowe złoto
EAN: 5907791188120

NOWOŚĆ



LO1_901A



czarny
EAN: 5907791165411



LO1_911A



czarny
EAN: 5907791191984

NOWOŚĆ



LO1_4M2A



patyna mat
EAN: 5907791122681



LO1_802A



różowe złoto
EAN: 5907791183583

NOWOŚĆ



LO1_902A



czarny
EAN: 5907791165428



LO1_912A



czarny
EAN: 5907791191991

NOWOŚĆ



LO1_4M3A



patyna mat
EAN: 5907791122698



LO1_803A



różowe złoto
EAN: 5907791188151

NOWOŚĆ



LO1_903A



czarny
EAN: 5907791165435



LO1_913A



czarny
EAN: 5907791192004

NOWOŚĆ



SZYLDY OKRĄGŁE

Szyld dzielony

KLUCZ



NOWOŚĆ

LO1_921A



czarny
EAN: 5907791187307



NOWOŚĆ

LO1_G01A



złoty
EAN: 5907791188106



LO2_001S



chrom
EAN: 5907791128805

WKŁADKA



NOWOŚĆ

LO1_922A



czarny
EAN: 5907791187314



NOWOŚĆ

LO1_G02A



złoty
EAN: 5907791183576



LO2_002S



chrom
EAN: 5907791128812

WC



NOWOŚĆ

LO1_923A



czarny
EAN: 5907791187321



NOWOŚĆ

LO1_G03A



złoty
EAN: 5907791188113



LO2_003S



chrom
EAN: 5907791128829



LO2_301S



satyna
EAN: 5907791112347



LO2_401S



patyna
EAN: 5907791112378



LO3_301A



satyna
EAN: 5907791112682



LO2_302S



satyna
EAN: 5907791112354



LO2_402S



patyna
EAN: 5907791112385



LO3_302A



satyna
EAN: 5907791112699



LO2_303S



satyna
EAN: 5907791112361



LO2_403S



patyna
EAN: 5907791112392



LO3_303A



satyna
EAN: 5907791112705



SZYLDY ZEWNĘTRZNE

Szyld dzielony z wkładką



LZ1_102A



satyna / chrom
EAN: 5907791115447



LZ1_4M2A



patyna mat
EAN: 5907791115454



LZ3_302A



anodowana satyna
EAN: 5907791115652



LZ3_402A



anodowana patyna
EAN: 5907791116581



LZ3_902A



anodowany czarny
EAN: 5907791130549



LZ4_302A



satyna
EAN: 5907791130167



LZ4_402A



patyna
EAN: 5907791130174



LZ5_102A



satyna / chrom
EAN: 5907791130198

AKCESORIA



ODBOJNIKI

Odbojniki drzwiowe



LAO_311M



satyna
EAN: 5907791141392



LAO_411M



patyna
EAN: 5907791141408



LAO_911M



czarny
EAN: 5907791181114



LAO_324M



satyna
EAN: 5907791141415



LAO_424M



patyna
EAN: 5907791103512



LAO_924M



czarny
EAN: 5907791181121



LAO_334A



satyna
EAN: 5907791127877



LAO_434A



patyna
EAN: 5907791109842



LAO_934A



czarny
EAN: 5907791181138



LAO_735M



transparentny
EAN: 5907791122148



Odbojnik



WKŁADKI

Wkładki bębnowe



ZESTAWY

Zestaw montażowy dla klamek z trzpieniem



mosiądz

3 klucze

WBB_022M

30x30 mm

EAN: 5906775349199



żeliwna

3 klucze

WBB_322N

30x30 mm

EAN: 5907791129130

WBB_327N

30x50 mm

EAN: 5907791129185

WBB_345N

40x50 mm

EAN: 5907791148148



LZM_310A

95 mm

EAN: 5906775349625



satyna



LZM_320A

120 mm

EAN: 5906775349656

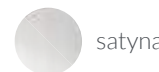

satyna



LZM_410A

95 mm

EAN: 5906775349663

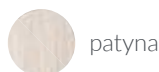

patyna



LZM_420A

120 mm

EAN: 5906775349670

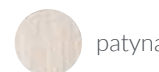

patyna

GARDEROBY

Słowo garderoba najczęściej kojarzone jest z oddzielnym pomieszczeniem, w którym przechowujemy ubrania. Jednak zwrot ten oznacza także specjalne rodzaje mebli ustawiane w dowolnych miejscach. Te elementy wyposażenia dzielimy na mobilne (z możliwością łatwego przesuwania) i stałe. Poznajmy zalety każdego z powyższych rodzajów.

GARDEROBY MOBILNE (NA KÓŁKACH)

To lekkie meble stworzone najczęściej z połączenia stali i tworzywa sztucznego, polecane do małych mieszkań, na działki, do akademików czy na plany zdjęciowe. Wyposażone są one w 4 koła, które po ustawieniu produktu w odpowiednim miejscu blokuje się za pomocą prostego mechanizmu. Najczęściej posiadają one jeden lub dwa drążki przeznaczone do wieszania ubrań, na których umieszcza się także np. wiszące, składane półki z włókniny przeznaczone do chowania obuwia. Wspomniane drążki, w zależności od modelu garderoby, mogą być regulowane zarówno pod kątem długości, jak i wysokości położenia, dzięki czemu mebel bardzo łatwo dopasujemy do ilości posiadanych ubrań oraz wymiarów pomieszczenia. Ogromnym plusem jest tu także bardzo łatwe składanie całej konstrukcji, które zajmie zaledwie kilka minut.

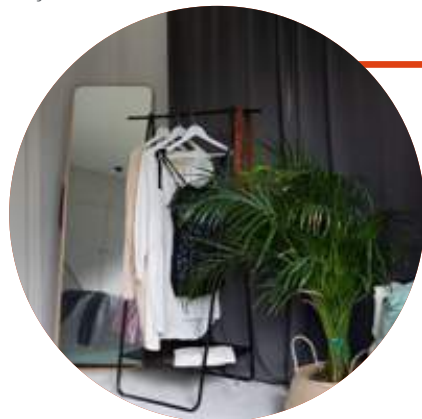

GARDEROBY STAŁE

Oferują dużą liczbę półek, styl a co za tym idzie bardzo dużą funkcjonalność, ponieważ mogą być dedykowane do sypialni oraz do przedpokoju. Wyposażone są np. w półki na buty czy ubrania oraz dużą liczbę wieszaków. Perfekcyjnie pomagają zachować porządek zarówno w małych jak i dużych pomieszczeniach oraz zoptymalizować wykorzystanie miejsca tak, aby wszystkie ubrania znalazły swoje miejsce.

Wykonane są one najczęściej ze stali w najmodniejszym czarnym wykończeniu bądź też połączenia współgrającego ze sobą brązu z czernią, dzięki czemu wnętrzu zostanie nadany nowoczesny, loftowy charakter. W zależności od potrzeb każdy może znaleźć idealną garderobę dla siebie.



STOJAKI NA OBUWIE

Są niewątpliwie wygodnym a zarazem praktycznym rozwiązaniem do zachowania ładu w przedpokoju. Do ich postawienia nie potrzeba dużo miejsca, a mogą również pełnić funkcję elementu dekoracyjnego w mieszkaniu.

Wyposażone są w zależności od potrzeb w 2, 3 a nawet 4 półki dzięki czemu sprawdzą się również dla większych rodzin. Do ich wyprodukowania użyte zostały różnorodne materiały, takie jak stal czy też bambus, dzięki czemu utrzymane są w stylu minimalistycznym łączącym dbałość o środowisko a także design. W trosce również o komfort oraz bezpieczeństwo podczas zakładania oraz zdejmowania obuwia stojak wyposażony został w miękkie siedzisko.

AKCESORIA DO GARDEROBY

Praktyczne, włókninowe pudełka w stonowanych wykończeniach zwiększą przestrzeń do przechowywania w sypialni oraz będą pasować do prawie każdej półki i wnętrza. Wykonane zostały z wytrzymałego materiału z uchwytami przez co ich wyciąganie jest bardzo łatwe. Dedykowane są do przechowywania różnego rodzaju rzeczy: ubrań, obuwia, pościeli, kocy, zabawek dla dzieci, kosmetyków. Pudełka zaopatrzone są w pokrywki przez co składowanie jest jeszcze prostsze ze względu na fakt, iż nie gromadzi się wewnątrz kurz. Dodatkowo dedykowane są specjalne organizery do bielizny z 4, 9 bądź 12 przegródkami. Wszystkie organizery oraz pudełka można w łatwy i wygodny sposób złożyć a także szybko schować.





MAJA

Wieszaki ściennie



Gwarancja



PAULO

Garderoba przenośna



Gwarancja



NOWOŚĆ

GKM_300S



biały / szary

EAN: 5907791192028

43x43x78 mm / 70x70x82 mm
udźwig 2 kg



NOWOŚĆ

GKM_700S



biały / czarny

EAN: 5907791192035

50x50x78 mm / 85x85x82 mm
udźwig 2 kg



GKA_210R



chrom / czarny

EAN: 5907791116628

950-1600x850-1300x420 mm
1 drążek
udźwig 15 kg



PAULO BIS

Garderoba przenośna



JACOB

Garderoby stojące



GKA_220R



chrom / czarny
EAN: 5907791116642

950-1600x850-1300x420 mm
2 drążki
udźwig drążka: 15 kg



GKJ_792S



czarny / brązowy
EAN: 5907791181145

1800x700x320 mm
2 półki, 9 wieszaków, siedzisko
udźwig: 1,5 kg wieszak
10 kg półka metalowa
80 kg półka drewniana



LOFT II

Garderoba stojąca

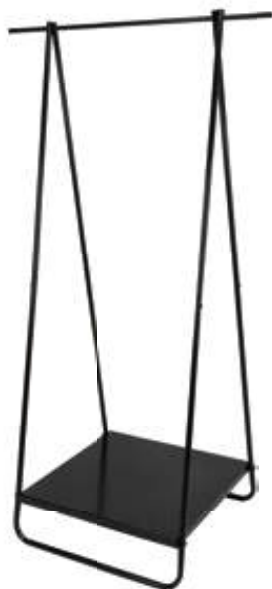

GKL_710S



czarny

EAN: 5907791182029

1400x520x470 mm

1 drążek

udźwig: 10 kg drążek

20 kg półka



Garderoba Loft II



LIVIA

Garderoba stojąca



ZOSIA BIS

Garderoba stojąca



GKI_710S



czarny / brązowy
EAN: 5907791187154

1600x500x400 mm
1 drążek
udźwig 10 kg



GKZ_753S



grafit
EAN: 5907791120557

1800x750x300 mm
3 półki, 5 wieszaków
udźwig: 20 kg półka



TOLA

Stojak na obuwie



Gwarancja



TOLA BIS

Stojak na obuwie



Gwarancja



DGA_021M



chrom

EAN: 5906775349045

DGA_421M



grafit

EAN: 5907791120397

670x500x250 mm

3 półki

udźwig 40 kg



DGA_022M



chrom

EAN: 5906775349052

DGA_422M



grafit

EAN: 5907791120403

850x750x250 mm

4 półki

udźwig 60 kg



GKZ_402S



szare / brązowe
EAN: 5907791185976

450x700x240 mm

2 półki

udźwig: 8 kg półka
100 kg siedzisko



Stojak na obuwie Zoja



FLORIDA

Akcesoria do garderoby



GFL_425M



bež
EAN: 5907791160140

950x280x280 mm
5 pótek



GFL_428M



bež
EAN: 5907791160157

950x280x280 mm
8 pótek



GFL_4B01



bež
EAN: 5907791160164

400x250x300 mm



GFL_4B02



bež
EAN: 5907791160171

600x300x400 mm



GFL_4B03



bež
EAN: 5907791160188

600x400x500 mm



GFL_4B04



bež
EAN: 5907791160195

280x330x150 mm



GFL_4B05



bež
EAN: 5907791160201

360x480x190 mm



GFL_4B06



bež
EAN: 5907791160218

310x310x310 mm



GFL_4B07



bež
EAN: 5907791160225

150x150x310 mm



GFL_4B08



beż
EAN: 5907791160232

150x310x310 mm



GFL_4B10



beż
EAN: 5907791160256

380x290x165 mm



GFL_4B12



beż
EAN: 5907791160270

300x300x155 mm



GFL_4B09



beż
EAN: 5907791160249

270x270x280 mm



GFL_4B11



beż
EAN: 5907791160263

380x290x325 mm



GFL_4B13



beż
EAN: 5907791160287

600x450x300 mm





JAMAJKA

Akcesoria do garderoby



NOWOŚĆ

GJA_425M



biały / grafitowy
EAN: 5907791189783

280x280x950 mm
5 półek



NOWOŚĆ

GJA_4B01



biały / grafitowy
EAN: 5907791189790

400x250x300 mm



NOWOŚĆ

GJA_4B04



biały / grafitowy
EAN: 5907791189806

280x330x150 mm



NOWOŚĆ

GJA_4B05



biały / grafitowy
EAN: 5907791189813

360x480x190 mm



NOWOŚĆ

GJA_4B09



biały / grafitowy
EAN: 5907791189820

270x270x280 mm



NOWOŚĆ

GJA_4B10



biały / grafitowy
EAN: 5907791189837

380x290x165 mm



NOWOŚĆ

GJA_4B12



biały / grafitowy
EAN: 5907791189844

300x300x155 mm



NOWOŚĆ

GJA_4B13



biały / grafitowy
EAN: 5907791189851

600x450x300 mm



NOWOŚĆ

GJA_4B14



biały / grafitowy
EAN: 5907791189868

330x230x90 mm



NOWOŚĆ

GJA_4B15

biały / grafitowy
EAN: 5907791189875

265x265x130 mm



NOWOŚĆ

GJA_4B16

biały / grafitowy
EAN: 5907791189882

450x360x120 mm



NOWOŚĆ

GJA_4B17

biały / grafitowy
EAN: 5907791189899

320x320x570 mm



NOWOŚĆ

GPH_4MPL

biały / grafitowy
EAN: 5907791189905

550x70x1100 mm



NOWOŚĆ

GPH_4SPL

biały / grafitowy
EAN: 5907791189912

550x70x850 mm



MIAMI

Akcesoria do garderoby



GMA_425M



bež
EAN: 5907791160294

280x280x950 mm
5 pótek



GMA_428M



bež
EAN: 5907791160300

280x280x950 mm
8 pótek



GMA_4B01



bež
EAN: 5907791160317

400x250x300 mm



GMA_4B02



bež
EAN: 5907791160324

600x300x400 mm



GMA_4B03



bež
EAN: 5907791160331

600x400x500 mm



GMA_4B04



bež
EAN: 5907791160348

280x330x150 mm



GMA_4B05



bež
EAN: 5907791160355

360x480x190 mm



GMA_4B06



bež
EAN: 5907791160362

310x310x310 mm



GMA_4B07



bež
EAN: 5907791160379

150x150x310 mm



GMA_4B08



beż
EAN: 5907791160386

150x310x310 mm



GMA_4B09



beż
EAN: 5907791160393

270x270x280 mm



GMA_4B10



beż
EAN: 5907791160409

380x290x165 mm



GMA_4B11



beż
EAN: 5907791160416

380x290x325 mm



GMA_4B12



beż
EAN: 5907791160423

300x300x155mm



GMA_4B13



beż
EAN: 5907791160430

600x450x300 mm



GPH_2MPL



beż
EAN: 5907791160119

550x70x1100mm



GPH_2SPL



beż
EAN: 5907791160133

550x70x850 mm



KUCHINOX
INSPIRACJA PŁYNIE Z WNETRZA

KUCHINOX POLSKA SP.Z O.O. SP.K.
AL.KOŚCIUSZKI 3, 90-418 ŁÓDŹ

BIURO OBSŁUGI KLIENTA
BOK@KUCHINOX.PL
TEL: +48 42 715 40 53
+48 42 715 40 56
+48 42 715 40 33
+48 42 715 40 34
+48 42 715 40 87
+48 42 639 74 99

WWW.KUCHINOX.PL