



METAL PRODUCTS CATALOGUE
METALLWARENKATALOG
CATÁLOGO DE PRODUCTOS
METÁLICOS

KUCHINOX
INSPIRATION COMES FROM THE INSIDE

KUCHINOX

INSPIRATION COMES FROM THE INSIDE

BRAND HANDLES

The metal products catalogue is fully inspirational. It includes classic patterns as well as fashionable novelties.

It is also a compendium of knowledge where we share our long experience. At Kuchinox company we believe that every detail is relevant. We pay attention to the quality of the raw materials, finishing details and the functionality of the product.

MARKEN-TÜRDRÜCKER

Der Metallwaren-Katalog ist eine Quelle voller Inspiration. Sie finden in ihm klassische Designs und modische Neuheiten. Er ist auch ein Wissenskompendium, in dem wir unsere langjährige Erfahrung teilen. Wir bei Kuchinox glauben, dass jedes Detail zählt. Wir legen Wert auf die Qualität der Rohstoffe, die Ausführungsdetails und die Funktionalität der Produkte.

MANILLAS DE MARCA

El catálogo de artículos metálicos es un material lleno de inspiración. Encontrará en él diseños clásicos y modernas novedades. Es también un compendio de conocimiento, en el que compartimos nuestra experiencia de muchos años. En la empresa Kuchinox creemos que cada detalle es importante. Le damos importancia a la calidad de las materias primas, los detalles de acabado y la funcionalidad de los productos.

In our wide range of products you can find handles, which will decorate your door, regardless of the style the house has been furnished in. Presented wardrobes will help to arrange even a small apartment. And practical metal products will make everyday life more functional.

Choosing Kuchinox products for your newly decorated home will be a great honour for us.

Im reichhaltigen Angebot finden Sie Türdrücker, die Ihre Türen schmücken werden, unabhängig davon, in welchem Stil das Haus eingerichtet wurde. Die präsentierten Garderoben werden dazu beitragen, selbst eine kleine Wohnung einzurichten. Und praktische Metallartikel erleichtern das tägliche Leben. Die Wahl von Kuchinox-Produkten für Ihr neu eingerichtetes Heim wird Ihnen zur Ehre gereichen.

En la amplia oferta encontrará manillas, que serán un adorno de la puerta, independientemente del estilo en que haya sido decorada la casa. Los armarios presentados ayudan a organizar incluso una vivienda pequeña. Y los prácticos artículos metálicos facilitan el funcionamiento diario. La elección de los productos Kuchinox para su casa recién amueblada será para nosotros un honor.



On the cover: QUBIK II series handle,
inside: LUSIOS series handle

Auf dem Cover: Türdrücker der Serie QUBIK
II, innen: Türdrücker der Serie LUSIOS

En la portada: manilla de la serie QUBIK II, en
el interior: manilla de la serie LUSIOS

TABLE OF CONTENT | INHALTSVERZEICHNIS | ÍNDICE

TECHNICAL INFORMATION TECHNISCHE INFORMATIONEN INFORMACIÓN TÉCNICA	6
DOOR HANDLES DIVISION AUFTEILUNG DER TÜRDRÜCKER DIVISIÓN DE LAS MANILLAS DE PUERTA	13
LONG PLATE OR SPLIT PLATE? LANGES ODER GETEILTES SCHILD? ¿PLACA O ROSETA?	17
HANDLE STYLES TÜRDRÜCKERSTILE ESTILOS DE MANILLAS	20
HANDLES WITH SPLIT PLATES TÜRDRÜCKER AUF GETEILTEM SCHILD MANILLAS CON ROSETA	34

Square plate | Quadratisches Schild | Roseta cuadrada 36

ARIA II	36	QUBIK II	44	IWA	52
GLORIA	36	ROY	46	LUSIOS	53
LUGA	38	SAVIO	47	QUBIK	54
LUXOR II	38	SILANA	49	RANDO	54
MADERA	39	TALIA	50	SAMARIA	55
NERO	40	TIMOR	50	VERA	56
PARVA	41	AREUS	51		
PRIMA	43	BINGO	52		

Round plate | Rundes Schild | Roseta redonda 56

ELIKA	56	DUET	64	RETRO	69
DOORKNOB	58	GEMELA	65	RODOS	70
TARA	60	GOA	65	STILO	70
VERDON	61	IRYS	66	ADA	71
ANDA	62	LUGA II	66	AGRA	71
ARIA	62	LUXOR	67	EWA	72
ASTER	63	MALTA	67	NOA	72
AURA	63	MARIO	68	STANDARD	73
DONA	64	MARS	68		

STAINLESS STEEL HANDLES | 74
TÜRDRÜCKER AUS ROSTFREIEM STAHL |
MANILLAS DE ACERO INOXIDABLE

FARO	76	MEDA	77	WIGO	79
LAGOS	76	PORTO	78		

HANDLES WITH LONG PLATES | 80
TÜRDRÜCKER AUF LANGSCHILD |
MANILLAS CON PLACA

ADA	82	GOA	88	PARVA	96
AGRA	82	IRYS	90	PRIMA	97
ARIA	84	LUGA II	91	QUBIK	98
ASTER	85	LUXOR	92	RANDO	99
AURA	86	MADERA	93	RETRO	100
BINGO	87	MALTA	94	RODOS	101
EWA	88	NOA	95	STILO	86

OUTDOOR HANDLES | AUSSENTÜRDRÜCKER | 103
MANILLAS EXTERIORES

AURIS	104	FRIDA	106
FLOKO	104	IRMA	106

GATE HANDLES | TORKLINKEN | 107
MANILLAS PARA PORTONES

BARON	108	MAGNAT	109
-------	-----	--------	-----

PLATES | SCHILDER | ROSETAS 111

Square plates Quadratische Schilder Rosetas cuadradas	112
Round plates Runde Schilder Rosetas redondas	118
Outdoor plates Außenschilder Rosetas exteriores	124

ACCESSORIES | ZUBEHÖR | ACCESORIOS 125

Bumpers Stopper Topes	126
Inserts Einsätze Cilindros	128
Mounting kits Montagesets Conjuntos de montaje	128

WARDROBES | GARDEROBEN | ARMARIOS 129

Bar racks Aufhänger 136		Footwear stands 140
Colgadores		Schuhständer
MAJA	136	Muebles zapateros
		TOLA
Mobile wardrobes 136		TOLA BIS
Mobile Garderoben 		ZOJA
Armarios móviles		
PAULO	136	Wardrobe accessories 142
PAULO BIS	137	Garderobenzubehör
		Accesorios para armarios
Standing wardrobes 137		FLORIDA
Garderobenständer 		JAMAJKA
Armarios de pie		MIAMI
JACOB	137	
LOFT II	138	
LIVIA	139	
ZOSIA BIS	139	

TECHNICAL INFORMATION | TECHNISCHE INFORMATIONEN | INFORMACIÓN TÉCNICA

WHAT IS THE HANDLE CONSTRUCTED OF?

A handle is a lever that every one of us uses everyday. Let's consider what does this seemingly obvious element placed in the door consist of.

HANDLE (DOOR PULL, HANDPIECE)

The lever coupled with a spring and rotating pin passing through the door. By pressing it, the spring resistance is overcome and the rotating pin starts the ratchet. The ratchet retracts and the door opens.

PLATE(SHIELD,ROSETTE)

Metal cover connected with the handle. There are long plates (they connect the handle and, e.g. the keyhole by oblong, mainly commonly rectangular element) and split (upper plate with a handle and lower plate with, e.g. a keyhole, are separate)

MOUNTING ELEMENTS

To attach the handle to the door properly, mounting elements are essential. The basic ones are the already mentioned rotating pins, through bolts and wood screws.

WORAUS BESTEHT EIN TÜRDRÜCKER?

Ein Türdrücker ist ein Hebel, den jeder von uns jeden Tag benutzt. Betrachten wir einmal, woraus dieses scheinbar offensichtliche Element an der Tür besteht.

TÜRDRÜCKER (TÜRGRIFF)

Ein federgekoppelter Hebel mit einem Drehstift, der durch die Tür reicht. Durch sein Niederdrücken wird der Federwiderstand überwunden und der Drückerstift aktiviert den Schlossfallenmechanismus. Die Schlossfalle zieht sich zurück und die Tür wird geöffnet.

SCHILD (ROSETTE)

Eine mit dem Türdrücker verbundene Metallabdeckung. Man unterscheidet Langschilder (sie verbinden den Türdrücker und z. B. das Schlüsselloch mit einem länglichen, meist rechteckigen Teil) und geteilte Schilder (das obere Schild mit einem Türdrücker und das untere Schild, z. B. mit einem Schlüsselloch, treten hier separat auf).

MONTAGEELEMENTE

Um den Türdrücker ordnungsgemäß an der Tür befestigen zu können, sind Montageelemente erforderlich. Die grundlegenden sind der bereits erwähnte Drückerstift, die durchgehenden Bolzen und Holzschrauben.

¿POR QUÉ ESTÁ FORMADA UNA MANILLA?

La manilla es una palanca que todos usamos a diario. Preguntémosnos por qué está formado este elemento aparentemente evidente colocado en las puertas.

MANILLA (TIRADOR, MANETA)

Es una palanca con un muelle y un vástago giratorio que atraviesa la puerta. Al presionarla se vence la resistencia del muelle y el vástago giratorio pone en marcha el mecanismo del picaporte. El picaporte se retira y la puerta se abre.

ROSETA (PLACA)

Cubierta metálica unida a la manilla. Se distinguen placas (unen la manilla y, por ejemplo, el orificio para la llave mediante una pieza alargada, normalmente rectangular) y rosetas (la roseta superior con la manilla y la roseta inferior, por ejemplo, con el orificio para la llave aparecen aquí por separado).

ELEMENTOS DE MONTAJE

Para fijar correctamente la manilla a la puerta son necesarios elementos de montaje. Los fundamentales son los ya mencionados vástagos giratorios, los tornillos pasantes y para madera.

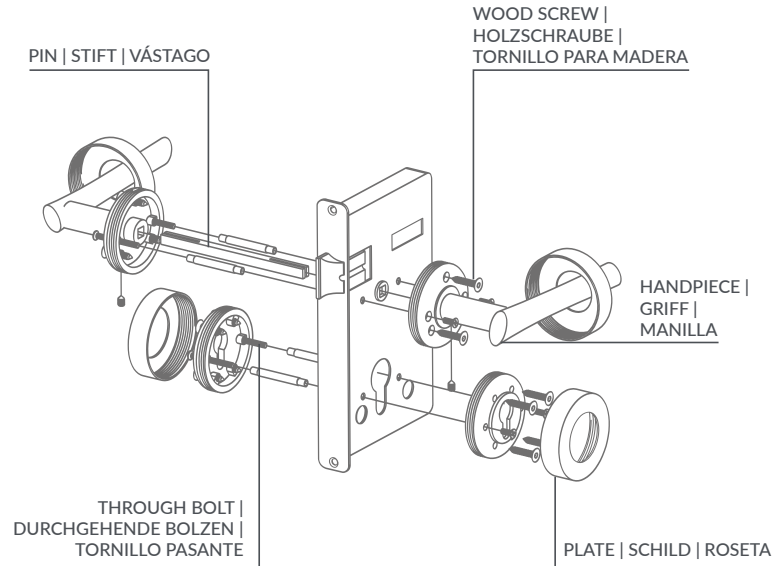

SPACING

The spacing between the handle pin and the lockhole is an important information when choosing the right handle. You can find this information at the door manufacturer or measure it yourself. There are many spacing options. The most common are 72 and 90 mm.

In our catalogue we marked the spacing with arrows for all product groups.

ABSTAND

Der Abstand zwischen dem Loch für den Drückerstift und dem Loch für das Schloss ist eine wichtige Information bei der Auswahl des richtigen Türdrückers. Diese Angabe können Sie beim Hersteller der Tür erfragen oder es selbst messen.

Es gibt eine Reihe von Abständen. Die beliebtesten sind 72 und 90 mm.

Im Katalog haben wir die Abstände für ganze Produktgruppen mithilfe von Pfeilen gekennzeichnet.

DISTANCIA ENTRE EJES

La distancia entre el orificio para el vástago de la manilla y el orificio de la cerradura es una información esencial a la hora de elegir la manilla adecuada. Esta información puede solicitarse al fabricante de la puerta o medirla uno mismo. Existen muchas distancias entre ejes. Las más populares son 72 y 90 mm.

En el catálogo hemos indicado la distancia entre ejes para grupos de productos completos mediante flechas.

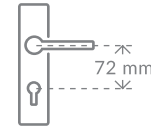

HANDLE MOUNTING

Kuchnix offers a wide range of various handles with long plates and with rosettes meeting the requirements of almost all users. Their quality is confirmed by 5-year manufacturer's warranty* and special designs which assure full safety while using. All necessary mounting elements are included which is an advantage of the Kuchnix handles allowing to avoid additional costs. We present the video instructions showing step by step how to attach each handle to the door properly.

*warranty conditions in the warranty card

TÜRDRÜCKERMONTAGE

Kuchinox bietet ein sehr breites Sortiment an verschiedenen Langschild- und Rosettengarnituren, die auf die Anforderungen fast jedes Benutzers zugeschnitten sind. Ihre Qualität wird durch eine 5-Jahres-Herstellergarantie* und spezielle Konstruktionen bestätigt, die eine absolute Gebrauchssicherheit gewährleisten. Ein Vorteil von Kuchinox-Türdrückern ist auch das Vorhandensein aller Montageelemente im Set, sodass keine zusätzlichen Kosten anfallen. Wir zeigen Ihnen in einer Videoanleitung Schritt für Schritt, wie Sie die jeweiligen Türdrücker richtig am Türblatt anbringen.

*Garantiebedingungen in der Garantiekarte

MONTAJE DE LAS MANILLAS

Kuchinox tiene en su oferta una muy amplia gama de diferentes manillas con placas y rosetas, adaptadas a los requisitos de prácticamente cualquier usuario. Su calidad está confirmada por la garantía de 5 años del fabricante* y unas estructuras especiales que garantizan la total seguridad de uso. Otra ventaja de las manillas Kuchinox es la presencia en el conjunto de todos los elementos de montaje, gracias a lo cual no se asumen costes adicionales. Presentamos instrucciones en vídeo que muestran, paso a paso, cómo fijar correctamente las diferentes manillas a la roseta de la puerta.

*condiciones de garantía en la tarjeta de garantía

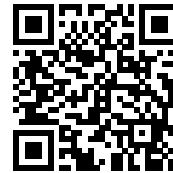

MOUNTING INSTRUCTION FOR HANDLE WITH ROSETTE

MONTAGEANLEITUNG FÜR ROSETTENGARNITUREN

INSTRUCCIONES DE MONTAJE DE MANILLAS CON ROSETA

<https://youtu.be/dUDkXDhGgeU>



MOUNTING INSTRUCTIONS FOR HANDLE WITH LONG PLATE

MONTAGEANLEITUNG FÜR LANG-SCHILDGARNITUREN

INSTRUCCIONES DE MONTAJE DE MANILLAS CON PLACA

<https://youtu.be/9HAFFNnfdZc>

NOT ONLY ALUMINIUM SO WHAT ARE THE HANDLES MADE OF

A material used to produce a handle has the influence not only on its appearance but also on its durability. Nowadays, the most popular models are made of zamak, aluminium, stainless steel, PVC and brass. Let's take a closer look at their properties.

ZAMAK

is an alloy made by connecting zinc (Zn) and aluminium (Al). Its properties are similar to aluminium but still, it has better processing and finishing properties, which makes it a popular material to produce handles.

ALUMINIUM

is a relatively durable and corrosion-resistant metal. Aluminium handles can be used as a gold imitation, polished, in matte chrome and many other ways. Currently, this kind of handles are the most common.

PLASTIC

it can be characterized by the fact that handles made of it are offered at a low price, are relatively durable and easy to clean. They are mostly mounted in offices and public utility buildings

STEEL

is a material definitely more expensive than the above but at the same time more massive, durable and damage-resistant. Therefore, it is often used for outdoor handles and places with high traffic congestion. The number of finishes and shapes given to steel models is almost infinite.

BRASS

is an alloy primarily used for making retro style handles. Brass models are finely cast, richly ornamented or interestingly styled. They can be characterized by massiveness and high prices as well.

In the catalogue, the material used, is marked with pictograms:



Made
of aluminium



Made
of zamak



Made
of stainless steel

NICHT NUR AUS ALUMINIUM ODER: | WORAUS TÜRDRÜCKER HERGESTELLT SIND

Das für die Herstellung eines Türdrückers verwendete Material beeinflusst sowohl sein Aussehen als auch seine Langlebigkeit. Die derzeit beliebtesten Modelle sind aus Zamak, Aluminium, Edelstahl, PVC und Messing. Schauen wir uns ihre Eigenschaften genauer an.

ZAMAK

ist eine langlebige Legierung aus einer Kombination von Zink (Zn) und Aluminium (Al). Ihre Eigenschaften sind denen von Aluminium ähnlich, aber sie hat bessere Verarbeitungs- und Endbearbeitungseigenschaften, dank denen sie gern bei der Herstellung von Türdrückern verwendet wird.

ALUMINIUM

ist ein relativ strapazierfähiges und korrosionsbeständiges Metall. Aluminiumtürdrücker können in Goldimitation, poliert, matt verchromt und in vielen anderen Varianten ausgeführt sein. Derzeit sind dies die gängigsten Arten von Türdrückern.

KUNSTSTOFF

zeichnet sich dadurch aus, dass die daraus hergestellten Türdrücker preiswert, relativ langlebig und leicht zu reinigen sind. Sie werden meist in Büros und öffentlichen Gebäuden montiert.

STAHL

ist ein wesentlich teureres Material als die oben genannten, aber auch robuster, langlebiger und widerstandsfähiger gegen Beschädigungen. Daher wird er häufig in Türdrückern für Außentüren und stark frequentierte Räume verwendet. Die Zahl der Ausführungen und Formen von Stahlmodellen ist nahezu unbegrenzt.

MESSING

ist eine Legierung, die hauptsächlich zur Herstellung von Türdrückern im Retrostil verwendet wird. Modelle aus Messing sind phantasievoll gegossen, reich verziert oder interessant stilisiert. Zu ihren Merkmalen gehören auch ihre Massivität und ihre recht hohen Preise.

Im Katalog wird das Ausführungsmaterial durch Piktogramme angegeben:



Hergestellt aus Aluminium



Hergestellt aus Zamak



Hergestellt aus rostfreiem Stahl

NO SOLO ALUMINIO, ES DECIR, DE QUÉ SE FABRICAN LAS MANILLAS

El material utilizado para fabricar manillas influye tanto en su aspecto como en su durabilidad. Actualmente los más populares son los modelos de zamak, aluminio, acero inoxidable, PVC y latón. Veamos con más detalles sus propiedades.

EL ZAMAK

es una resistente aleación formada por zinc (Zn) y aluminio (Al). Tiene unas propiedades similares a las del aluminio, pero posee unas mejores propiedades para su mecanizado y acabado, gracias a lo cual es muy utilizado para la producción de manillas.

EL ALUMINIO

es un metal relativamente duradero y resistente a la corrosión. Las manillas de aluminio pueden ser acabadas como imitación de oro, pulidas, cromadas mate y de muchas otras formas. Actualmente son los tipos de manillas más frecuentes.

EL PLÁSTICO

se caracteriza porque las manillas fabricadas con él son económicas, relativamente duraderas y sencillas de limpiar. Normalmente se montan en oficinas y edificios públicos.

EL ACERO

es un material claramente más caro que los anteriores, pero al mismo tiempo más sólido, duradero y resistente a los daños. Por eso se utiliza a menudo en manillas para puertas exteriores y habitaciones con una gran intensidad de tránsito. La cantidad de acabados y formas dadas a los modelos de acero es casi ilimitada.

EL LATÓN

es una aleación utilizada principalmente para fabricar manillas en estilo retro. Los modelos de latón son moldeados de forma imaginativa, profusamente adornados o estilizados de manera interesante. Sus características son también su solidez y unos precios bastante elevados.

En el catálogo el material de fabricación ha sido indicado mediante pictogramas:



Fabricado en aluminio



Fabricado en zamak



Fabricado en acero inoxidable

DOOR HANDLES DIVISION BY THE PLACE OF APPLICATION

Handles are divided due to several features. These are the material used for production, style and the place of application mentioned below.

INDOOR HANDLES FOR ROOMS

While choosing them, the design plays a very important role, it must be matched not only with the door itself but also the interior. You can successfully choose golden handles ornamented with crystals. The advantages, relevant as well, are its light weight and ergonomics. Materials used to produce room handles are mostly zamak and aluminium.



INDOOR HANDLES FOR BATHROOMS

Their design matches room handles. Their basic advantage is the toilet lock which has the open/close holder from the inside whereas from the outside an emergency open mechanism.

INDOOR HANDLES FOR OFFICES AND PUBLIC PLACES

Here, the design is less important while the durability matters. Office handles are intensively used by many people. Therefore, it is worth choosing, e.g. stainless steel models. What is crucial is that thanks to simple shapes they are easy to clean and safe.



OUTDOOR HANDLES

The outdoor door models are the most demanding of handles. Their features should therefore be corrosion and weather resistance as well as the anti-drill protection. Corrosion-resistance is marked with classes from 0 (lowest) to 4 (highest), the same applies to anti-burglary protection. As for the general strength (according to EN 1906), the best products are classified with the 3rd and 4th class of the category of use. The material used for the production of the outdoor handles is mostly steel, less often aluminium.



GATE AND WICKET HANDLES

As they are permanently exposed to unfavourable external factors, they should be made of durable steel and protected by e.g. precise powder coating. Often, there is a handle on one side of the plate whereas on the other, a holder, thanks to which it is not possible to open a wicket or a gate by an accidental passer-by. A feature of the above mentioned handles is that they are mostly mounted on a long plate, where, in the lower part, there is a keyhole for cylinder insert.



EINTEILUNG DER TÜRDRÜCKER NACH DEM JEWEILIGEN EINSATZORT

Die Türdrücker werden aufgrund mehrerer Merkmale eingeteilt. Dazu gehören das bei der Herstellung verwendete Material, das Design und auch der Ort ihres Einsatzes, auf den wir im Folgenden eingehen werden.

INNENTÜRDRÜCKER

Bei ihrer Auswahl spielt das Design eine wichtige Rolle, das sowohl zur Tür selbst als auch zur Einrichtung passen muss. Hier kann man erfolgreich goldene Türdrücker wählen, die mit Kristallen verziert sind. Zu den Vorteilen, die auch hier von Bedeutung sind, gehören das geringe Gewicht und die Ergonomie. Die Materialien, die für die Herstellung von Zimmertürdrückern verwendet werden, sind hauptsächlich Zamak und Aluminium.

INNENTÜRDRÜCKER FÜR BADEZIMMER

Das Design ist auf die Zimmertürdrücker abgestimmt. Ihr Hauptmerkmal ist das Vorhandensein eines WC-Schlusses, das an der Innenseite einen Griff zum Öffnen/Schließen der Tür und an der Außenseite einen Notöffnungsmechanismus aufweist.

INNENTÜRDRÜCKER FÜR BÜROS UND ÖFFENTLICHE RÄUME

Hier kommt es weniger auf das Design, sondern mehr auf die Langlebigkeit an. Schließlich werden Bürotürdrücker von vielen Menschen sehr intensiv genutzt. Es lohnt sich daher, Modelle aus zum Beispiel rostfreiem Stahl zu wählen. Reinigungsfreundlichkeit und Sicherheit sind ebenfalls wichtige Aspekte, die durch einfache Formen gewährleistet werden.

TÜRDRÜCKER FÜR AUßENTÜREN

Die Modelle für Außentüren gehören zu den anspruchsvollsten Türdrückern. Sie sollten sich daher durch Korrosions- und Witterungsbeständigkeit sowie einen Aufbohrschutz auszeichnen. Die Korrosionsbeständigkeit wird mit den Klassen von 0 (die niedrigste) bis 4 (die höchste) gekennzeichnet, gleiches gilt für den Einbruchschutz. Was die allgemeine Lebensdauer (gemäß EN 1906) betrifft, so sind die besten Produkte die der Anwendungsklassen 3 und 4. Das Material, das für die Herstellung von Außentürdrückern verwendet wird, ist meistens Stahl, seltener Aluminium.

KLINKEN FÜR TORE UND PFORTEN

Da sie dauerhaft ungünstigen äußeren Einflüssen ausgesetzt sind, sollten sie aus langlebigem Stahl bestehen und beispielsweise durch eine präzise Pulverbeschichtung geschützt sein. Oft befindet sich auf der einen Seite des Schilds eine Klinke und auf der anderen Seite ein Griff, wodurch es nicht möglich ist, eine Pforte oder ein Tor durch einen zufällig vorbeigehenden Passanten zu öffnen. Die meisten der oben genannten Klinken zeichnen sich auch dadurch aus, dass sie auf einem Langschild montiert sind, dessen unterer Teil ein Loch für einen Zylindereinsatz aufweist.

CLASIFICACIÓN DE LAS MANILLAS EN FUNCIÓN DE SU LUGAR DE UTILIZACIÓN

Las manillas se dividen en función de varias características. Entre estas se encuentran el material usado en la producción, el estilo, así como el lugar de utilización, sobre el que escribimos a continuación.

MANILLAS INTERIORES PARA HABITACIONES

Durante su selección el diseño juega un papel clave, ya que debe conjuntar tanto con la propia puerta como con el interior. Aquí es posible decidirse con éxito por manillas doradas, adornadas con cristales. Unas ventajas, que también son aquí importantes, son el reducido peso y la ergonomía. Los materiales utilizados para la producción de manillas de habitación son sobre todo el zamak y el aluminio.

MANILLAS INTERIORES PARA BAÑOS

Por su diseño se adaptan a las manillas de habitación. Su característica básica es la presencia de un cierre WC, que en la parte interior tiene un pestillo que permite abrir / cerrar la puerta, mientras que en la parte exterior un mecanismo de apertura de emergencia.

MANILLAS INTERIORES PARA OFICINAS Y ESPACIOS PÚBLICOS

Aquí importa menos el diseño y más una mayor durabilidad. Las manillas en las oficinas son utilizadas de forma intensa por muchas personas. Por lo tanto, merece la pena elegir modelos fabricados de acero inoxidable, por ejemplo. También son cuestiones claves la facilidad de limpieza y la seguridad, algo garantizado por las formas sencillas.

MANILLAS PARA PUERTAS EXTERIORES

Los modelos de puertas exteriores son más exigentes con las manillas. Por lo tanto, sus características deberían ser la resistencia a la corrosión y a la acción de los agentes atmosféricos, así como la presencia de protecciones frente a robos. La resistencia a la corrosión se indica mediante clases, desde 0 (la más baja) hasta 4 (la más alta). Algo idéntico para la protección frente a robos. En cuanto a la resistencia general (de conformidad con la norma EN 1906), los mejores productos serán los determinados con las clases 3 y 4 de categoría de uso. El material utilizado para la producción de manillas exteriores es por lo general el acero, más raramente el aluminio.

MANILLAS PARA PORTONES Y PORTILLOS

Ya que están expuestas a la acción permanente de los agentes exteriores adversos deberán estar fabricadas en acero resistente y protegidas mediante un recubrimiento de pintura en polvo, por ejemplo. A menudo en una parte de la roseta se encuentra una manilla, mientras que de la otra un pestillo, gracias al cual no es posible que un transeúnte abra el portillo o el portón. Una característica de las anteriores manillas es también que en su mayoría se montan con placa, en cuya parte inferior se encuentra el orificio para la llave del cilindro.

LONG PLATE OR SPLIT PLATE?

HOW TO CHOOSE A HANDLE

A handle consists not only of a handpiece and spring mechanism responsible for its proper operation. An inseparable part of the handle set are plates (shields, covers, rosettes), attached to the handles by pins. Among them, in general, long plates and split plates can be distinguished. What are they characterized by? Which one to choose for your house or flat?

LONG PLATES

These models combine a handle and, e.g. a keyhole, by a long, mostly rectangular part. When buying, you should know the exact spacing of the lock. Visually they seem more solid than short plates (which is only an impression). Long plates are available in four versions:

- with a keyhole,
- with a cylinder insert hole,
- with a toilet lock,
- without holes (room plates).

For indoor wings, the decision is only up to the user.

SHORT PLATES

In this case, a handle (upper plate) and a lock (lower plate) are provided separately, so it is easier to fit them as far as the spacing of the handle and the lock is concerned. Often with room door, there is no need to mount a lock

so a short plate is a much better solution here as it takes less space. It is worth mentioning that manufacturers usually offer wider range of handle patterns for such models. The example are doorknobs, which are exceptional models decorating the space of a room. As in split plates, the lower parts of short plates are also divided to types with a keyhole, with a cylinder insert hole (lock) and with a toilet lock. Lower plates without a penetration are less common.

PLATE TYPE DESIGNATIONS

Depending on a room which the door lead to, a proper handle plate must be used. Our offer includes five types, split plate, long full plate, toilet plate, plate with a key and insert type plate.



Split plate



Full plate



Toilet plate



Plate with a key



Insert type plate

LANGES ODER GETEILTES SCHILD?

WIE WIR TÜRDRÜCKER AUSWÄHLEN

Ein Türdrücker besteht nicht nur aus dem Griff und dem Federmechanismus, der für sein ordnungsgemäßes Funktionieren verantwortlich ist. Ein untrennbarer Bestandteil der Klinkengarnitur sind auch die Schilder (Abdeckungen, Rosetten), die mit den Türdrückern durch Stifte verbunden sind. Ihre Hauptunterteilung ist die in Langschilder und geteilte Schilder. Was sind die Merkmale der beiden? Welches ist das richtige für das eigene Haus oder die eigene Wohnung?

LANGSCHILDER

Diese Modelle verbinden den Türdrücker und z. B. das Schlüsselloch durchein längliches, meist rechteckiges Teil. Beim Kauf ist es daher wichtig, den genauen Schlossabstand zu kennen. Optisch machen sie den Eindruck, robuster als Kurzschilder zu sein (aber das ist nur ein Eindruck). Langschilder gibt es in vier Ausführungen:

- mit einer Aussparung für einen Schlüssel,
- mit einer Aussparung für einen Zylindereinsatz (für ein Schloss),
- mit einem WC-Schloss,
- ohne Aussparungen (Zimmertürschilder).

Bei innenliegenden Flügeln hingegen hängt die Entscheidung ganz vom Benutzergeschmack ab.

KURZSCHILDER

In diesem Fall Türdrücker (oberes Schild) und Schloss (unteres Schild). sie sind separat erhältlich und lassen sich daher in Bezug auf die Abstände von Türdrücker und Schloss leichter anpassen. Da oft kein Schloss in einer Zimmertür eingebaut werden muss, ist ein Kurzschild die bessere Lösung mit geringem Platzbedarf. sie sind separat erhältlich und lassen sich daher in Bezug auf die Abstände von Türdrücker und Schloss leichter anpassen.

BEZEICHNUNGEN DER SCHILDERTYPEN

Je nachdem, zu welchem Raum die Tür führt, sollte ein geeignetes Türdrückerschild verwendet werden. Das Angebot umfasst fünf Typen, geteilte Schilder, Langschilder, WC-Schilder, Schlüsselschilder und Schilder für Schließzylinder.



geteiltes
Schild



Schild



WC-
Schild



Schlüssel-
schild



Schild
für einen
Schließzy-
linder

¿PLACA O ROSETA?

CÓMO ELEGIMOS LAS MANILLAS

La manilla no solo está formada por la maneta y el mecanismo de muelle responsable de su correcto funcionamiento. Una parte inseparable del conjunto de la manilla son también las rosetas (placas, protectores), unidas a la manilla mediante el vástago. Se dividen principalmente en placas y rosetas. ¿Por qué se caracterizan cada una de ellas? ¿Cuál elegir para nuestra casa o vivienda?

PLACAS

Estos modelos unen la manilla y, por ejemplo, el orificio para la llave mediante una pieza alargada, normalmente rectangular. Durante su compra se debe conocer, por lo tanto, la distancia entre ejes exacta de la cerradura. Visualmente dan la sensación de ser más sólidas que las rosetas (sin embargo, esto es solamente una sensación). Las placas se presentan en cuatro versiones:

- con orificio para la llave,
- con orificio para el cilindro (cerradura),
- con bloqueo WC,
- sin orificios (placas de habitación).

En el caso de las placas interiores la decisión depende únicamente de los gustos del usuario.

ROSETAS (PLACAS CORTAS)

En este caso la manilla (roseta superior) y la cerradura

(roseta inferior) se presentan por separado, por lo que es más sencillo adaptarlas a la distancia entre la manilla y la cerradura. A menudo en las puertas de habitación no es necesario montar una cerradura, por lo que una roseta es aquí la mejor solución, que ocupa poco espacio. También merece la pena destacar que los fabricantes tienen por lo general una oferta más amplia para estos modelos si se trata del diseño de manillas. Un ejemplo son los pomos de cristal, que son excepcionales modelos que decoran el espacio de la habitación. Al igual que en las rosetas, las partes inferiores de las placas cortas se dividen en tipos con orificio para la llave, con orificio para el cilindro (cerradura) y con bloqueo WC. Más raramente encontramos rosetas inferiores sin orificio.

INDICACIÓN DE LOS TIPOS DE ROSETAS/PLACAS

En función de la habitación a la que lleve la puerta se debe utilizar la roseta adecuada. En la oferta hay cinco tipos, roseta, placa ciega, placa WC, placa con llave y placa del tipo cilindro.



roseta



placa
ciega



placa
WC



placa
con llave



placa
del tipo
cilindro

HANDLE STYLES

WHICH PATTERNS TO CHOOSE FOR YOUR INTERIOR?

Modern, rustic, small or big, sharp or round shapes... Nowadays, there are plenty of different handle patterns. Trying to satisfy sophisticated tastes of customers, manufacturers market more and more diverse series. How to find yourself among them? How to choose a perfect handle in terms of style?

FINISHES

Steel, zamak or aluminium handles are finished in several ways. The most common of them include nickel plating, chrome plating, powder coating, painting or brass plating. These coatings are available in matte or glossy versions. Durability of each of them is almost identical, so the choice depends on individual taste and a matching interior.

COLOURS

The colour of the handle should match not only the colour of the door but also colours of the interior itself. Also pay attention to the finishing of fittings and hinges-although these elements are hardly visible on a daily basis, as if they don't go together with handles, they create an uninteresting set. Those who prefer restrained, subtle designs can choose this product in a way it does not stand out with a shade from the door wing. When style of the interior is bolder, you can cho-

ose handles in intense or even bright colours. We also offer models with combine different colours or textures (e.g. chrome satin PRIMA handles).

Below are all available finishes.



HANDPIECE SHAPES

What distinguishes a handle handpiece is not only the colour but also its shape. An interesting and asymmetrical form is provided in DONA models, whereas smooth wave line in MALTA handles. On the other hand RETRO, STILO or BARON series offer fancifully curved and originally ornamented handpieces referring to rustic style.

DECORATIVE ELEMENTS

Various decorative elements made of crystal, glass or plastic are mounted in the handles. Worth the attention are, e.g. Kuchnixox doorknobs, the crystal handpiece is in black, transparent white or pink, or GLORIA handles which have 9 little crystals embedded. Another eye-catching solution is used in ELIKA and TARA handles. They have glass elements in black or white in their front part.



DID YOU KNOW THAT...

Among doors, as well as handles and locks, left hand and right hand ones can be distinguished. Just stand in front of the door as if you wanted to enter the room. If the hinge is on your left – you have a left side door, and if on your right – a right side door.

LEFT SIDE DOOR

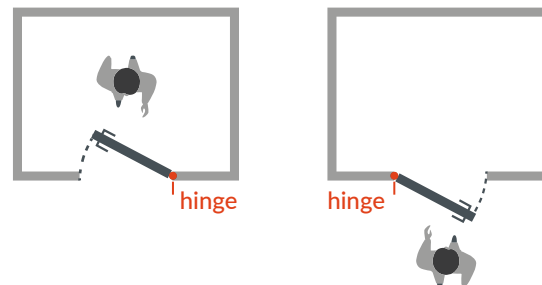

RIGHT SIDE DOOR

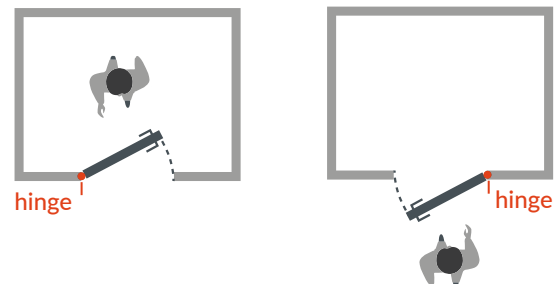

TÜRDRÜCKERSTILE

WELCHE DESIGNS SOLLTEN SIE FÜR IHRE INNEN-EINRICHTUNG WÄHLEN?

Moderne, rustikale, kleine und große, spitze und runde Formen ... Heutzutage gibt es unzählige Türdrückerdesigns. In dem Bemühen, dem anspruchsvollen Kundengeschmack gerecht zu werden, bringen die Hersteller immer mehr unterschiedliche Serien auf den Markt. Wie findet man sich unter ihnen wieder? Wie wählt man den perfekten Türdrücker in Bezug auf das Design aus?

AUSFÜHRUNGEN

Stahl-, Zamak- oder Aluminiumtürdrücker sind auf verschiedene Weise ausgeführt. Am häufigsten trifft man auf vernickelte, verchromte, pulverbeschichtete, patinierte, vermessingte. Diese Beschichtungen sind in matten und glänzenden Ausführungen erhältlich. Die Langlebigkeit von jeder von ihnen ist fast identisch, daher hängt die Wahl vom individuellen Geschmack und der Anpassung an das Interieur ab.

FARBEN

Die Farbe des Türdrückers sollte auf das Farbschema der Tür, aber auch auf die Farben der Inneneinrichtung abgestimmt sein. Achten Sie auch auf die Ausführung der Beschläge und Scharniere - diese Elemente sind zwar im Alltag kaum sichtbar, aber wenn sie nicht mit den Türdrückern harmonieren, entsteht ein reizloses Gesamtbild.

Wer eine zurückhaltende, dezente Gestaltung bevorzugt, kann das betreffende Produkt wählen, damit es sich nicht im Farbton des Türblatts abhebt. Ist der Einrichtungsstil etwas gewagter, können Griffe in intensiven oder sogar grellen Farben gewählt werden. Es werden auch Modelle angeboten, bei denen verschiedene Farben und Texturen kombiniert werden (z. B. die Türdrücker aus satiniertem Chrom PRIMA).

Alle verfügbaren Ausführungen sind unten aufgeführt:

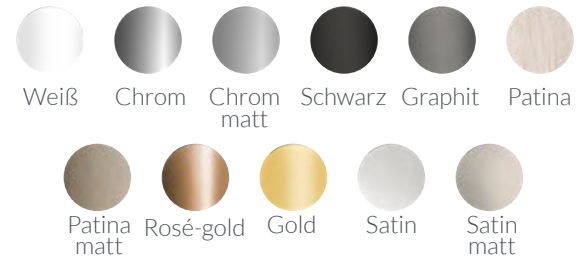

GRIFFFORMEN

Der Griff des Türdrückers zeichnet sich nicht nur durch seine Farbe, sondern auch durch seine Form aus. So haben die Griffe der Modelle DONA eine interessante, asymmetrische Form, während die Türdrücker MALTA eine sanfte Wellenlinienform auszeichnet. Bei den Produkten der Serien RETRO, STILO oder BARON finden wir Türdrücker, die auf den rustikalen Stil verweisen – sie sind fantasievoll gebogen und originell verziert.

DEKORELEMENTE

Die Türdrücker sind mit einer Vielzahl von Dekorelementen aus Kristall, Glas oder Kunststoff versehen. Erwähnenswert sind zum Beispiel die Kuchinox-Knäufe mit Kristallgriffen in Schwarz oder transparentem Weiß und Rosa oder die Türdrücker GLORIA mit 9 kleinen, in den Griff eingelassenen Kristallen. Eine weitere ins Auge fallende Lösung wird zum Beispiel bei den Türdrückern ELIKA und TARA verwendet. In ihrem vorderen Teil befinden sich Glaselemente in Weiß oder Schwarz.



WUSSTEN SIE, DASS ...

Türen und damit auch Türdrücker und Schlösser werden in linke und rechte unterschieden. Stellen Sie sich vor die Tür, als wollten Sie den Raum betreten. Wenn sich das Scharnier links befindet, haben Sie eine linke Tür, wenn rechts, eine rechte.

LINKE TÜR

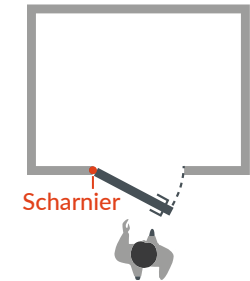
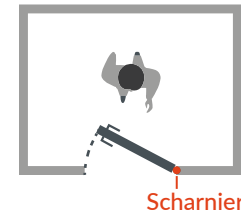

RECHTE TÜR

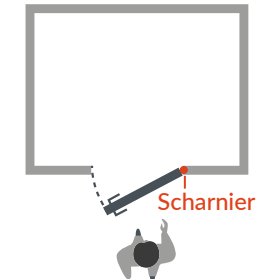
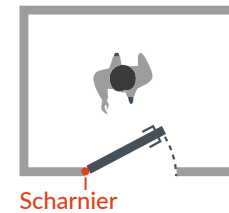

ESTILOS DE MANILLAS

¿QUÉ DISEÑOS ELEGIR PARA NUESTROS INTERIORES?

Modernas, rústicas, pequeñas y grandes, con formas angulosas o redondeadas... Actualmente los diseños de manillas son innumerables. Los fabricantes, intentando responder a los refinados gustos de los clientes, introducen en el mercado series cada vez más variadas. ¿Cómo orientarse entre ellas? ¿Cómo elegir una manilla ideal desde el punto de vista del estilo?

ACABADO

Las manillas de acero, zamak o aluminio están acabadas de varias formas. Los más frecuentes son niquelado, cromado, pintura en polvo, con pátina, latonado. Estos revestimientos están disponibles en versiones mate y brillante. La duración de cada uno de ellos es casi idéntica, por lo que la elección depende de los gustos individuales y de su combinación con el interior.

COLORES

El color de la manilla deberá elegirse según los colores de la puerta, pero también de los tonos presentes en el propio interior. Prestemos también atención al acabado de los herrajes y bisagras: a pesar de que son elementos poco visibles en el día a día, si no conjuntan con las manillas forman con ellas una composición poco interesante.

Los que prefieren las decoraciones armonizadas, sutiles, pueden elegir el producto de manera que no se distinga por su tono de la hoja de la puerta. Si el estilo del interior es más atrevido, entonces se pueden elegir unas manillas en unos colores intensos, o sencillamente vivos. A la venta también hay modelos que combinan diferentes colores y texturas (por ejemplo, las manillas cromadas-satinadas PRIMA).

A continuación se han presentado todos los acabados disponibles:

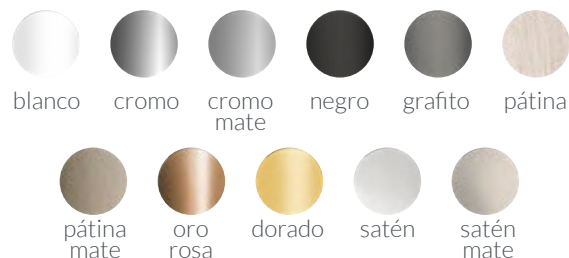

FORMAS DE LA EMPUÑADURA

La empuñadura de la manilla destaca no solo por el color, sino por la forma. Una interesante forma asimétrica tienen, por ejemplo, las empuñaduras en los modelos DONA, mientras que una forma con líneas suaves distingue a las manillas MALTA. En los productos de las series RETRO, STILO o BARON encontramos empuñaduras que recuerdan a un estilo rústico: dobladas con fantasía y originalmente decoradas.

ELEMENTOS DECORATIVOS

En las manillas se montan diferentes elementos decorativos fabricados de cristal, vidrio o plásticos. Merecen la atención los pomos Kuchinox, cuyas empuñaduras de cristal se mantienen en color negro o blanco y rosa transparente o bien las manillas GLORIA, que tienen incrustados en la empuñadura 9 pequeños cristales.

Otra solución que llama la atención se ha empleado en las manillas ELIKA y TARA, por ejemplo. En su parte frontal se han colocado elementos de vidrio en colores blanco o negro.



Manilla de la serie TARA

¿SABÍAS QUE...?

Las puertas, y por lo tanto también las manillas y las cerraduras, se dividen de apertura izquierda y derecha. Ponte frente a la puerta como si quisieras entrar en la habitación. Si tienes la bisagra en el lado izquierdo, tienes una puerta de apertura izquierda, si en el derecho, derecha.

PUERTA DE APERTURA IZQUIERDA

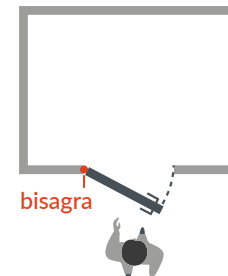
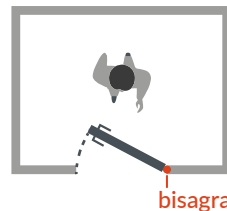

PUERTA DE APERTURA DERECHA

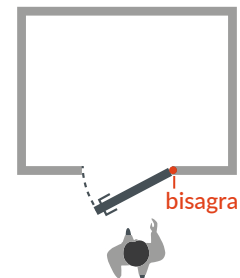
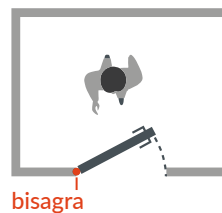

INTERIOR DESIGN STYLES AND HANDLES MATCHING THEM

GLAMOUR STYLE

Glamour is the style that dates back to the 20th century. It was born as an opposition to the previously reigning minimalism. It is characterized mostly by timeless chic, exclusivity, decorativeness and combining inspirations from various types of arrangements. In a glamour atmosphere, everything has to shine, which is why we recommend GLORIA handles with 9 crystals in black or transparent white. Unique crystal doorknobs (black, transparent, pink) might be a good choice as well.

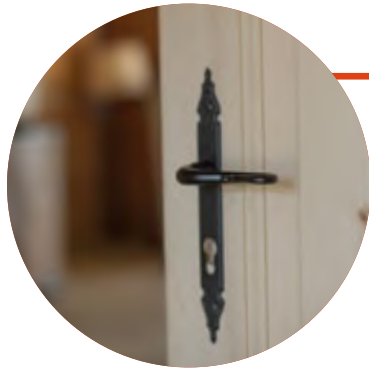

RETRO STYLE

An apartment from grandmother or great-grandmother times with a slight breath of modernity – this is how you could describe the retro style at a glance. Everything that refers to the style of several decades ago will work here – paintings in golden frames, cuckoo clocks, heavy curtains, massive wooden and upholstered furniture, classic parquet on the floor. RETRO and STILO handles (fancifully cast, in the colour of antique brass) as well as a bit simpler in the form of RHODES will perfectly fit into such an interior.

LOFT STYLE

Lofts are postindustrial interiors, the history of which dates back to 1900. Everything started in Paris, where the local bohemians used old factories and warehouses for workshops. Living in lofts became popular in the 1960's and since then it has been associated with everyday comfort, individualism and creative freedom. Lofts are distinguished mostly by natural, raw structures, open spaces and industrial minimalism. When choosing handles for them, it is worth taking a closer look at models such as SILANA with rosette, VERDON with rosette or QUBIK.



SCANDINAVIAN STYLE

Minimalistic and very functional solutions, natural raw materials and bright colours – this is what we appreciate the Scandinavian style for. Materials used in such an interior are mostly raw wood, linen, cotton and wool. The colours are kept in shades of warm white, blue, light blue, bottle green and contrasting black and grey. Also remember to provide as much natural light as possible. Handles that are worth considering while designing Scandinavian interior are among others models such as IRYS and ASTER, black or white QUBIK II or MEDA.



MARINE STYLE

The marine style is what we associate with summer and seaside. The sound of water, smooth line of waves, white clouds... That is why marine interiors are provided with blue and white colours and everything that has smooth lines just as those you can see in NOA, MALTA or TALIA handles.

EINRICHTUNGSSTILE UND DAZU PASSENDE TÜRDRÜCKER

GLAMOUR-STIL

Glamour ist ein Stil, der auf den Beginn des 20. Jahrhunderts zurückgeht. Er wurde als Opposition zum vorher herrschenden Minimalismus geboren. Er zeichnet sich vor allem durch zeitlosen Chic, Exklusivität, Dekorativität und eine Kombination von Inspirationen aus verschiedenen Arten von Arrangements aus. In einem glamourösen Ambiente muss alles strahlen, deshalb empfehlen wir die Türdrücker GLORIA mit 9 Kristallen in Schwarz oder transparentem Weiß. Die einzigartigen (schwarzen, transparenten, rosafarbenen) Kristallknäufe sind ebenfalls eine gute Wahl.

RETRO-STIL

Eine Wohnung aus Großmutterns oder Urgroßmutterns Zeiten, mit einem Hauch von Modernität – so könnte man den Retro-Stil kurz und knapp beschreiben. Alles, was an den Stil vergangener Jahrzehnte erinnert, passt hierher: goldgerahmte Gemälde, Kuckucksuhren, schwere Vorhänge, massive Holz- und Polstermöbel, klassische Parkettböden. Die Türdrücker RETRO und STILO (mit fantasievолlem Guss aus antikem Messing) sowie die etwas schlichteren Türdrücker RODOS fügen sich perfekt in solche Interieurs ein.

LOFT-STIL

Lofts sind postindustrielle Innenräume, die auf die Zeit um 1900 zurückgehen. Alles begann in Paris, wo die lokale Bohème alte Fabriken und Lagerhäuser als Ateliers nutzte. Das Wohnen in Lofts wurde in den 60er

Jahren des 20. Jahrhunderts populär und wird seitdem mit Alltagskomfort, Individualismus und kreativer Freiheit assoziiert. Lofts zeichnen sich vor allem durch natürliche, rohe Strukturen, offene Räume und einen industriellen Minimalismus aus. Bei der Auswahl der dazu passenden Türdrücker lohnt sich ein Blick auf die Modelle wie SILANA auf einer Rosette, VERDON auf einer Rosette oder QUBIK.

SKANDINAVISCHER STIL

Minimalistische und hochfunktionale Lösungen, natürliche Rohstoffe und leuchtende Farben – dafür wird der skandinavische Stil unter anderem geschätzt. Die Materialien, die in einem solchen Interieur verwendet werden, sind hauptsächlich Rohholz, Leinen, Baumwolle und Wolle. Die Farben sind in Schattierungen von Weiß, Blau, Azur, Flaschengrün und kontrastierendem Schwarz und Grau gehalten. Denken wir auch an möglichst viel natürliches Licht. Zu den Türdrückern, die für eine skandinavische Inneneinrichtung infrage kommen, gehören die seidenmatten Modelle IRYS und ASTER sowie die weißen oder schwarzen QUBIK II und MEDA.

MARITIMER STIL

Der maritime Stil ist alles, was man mit einem Sommer am Meer verbindet. Das Rauschen des blauen Wassers, die sanften Linien der Wellen, die weißen Wolken ... Aus diesem Grund dreht sich in der maritimen Einrichtung alles um weiße und blaue Farben und alles um sanfte Wellenlinien, wie wir sie bei den Türdrückern NOA, MALTA oder TALIA wiederfinden.

ESTILOS DE DECORACIÓN DE INTERIORES Y MANILLAS QUE CONJUNTAN CON ELLOS

ESTILO GLAMOUR

Glamour es un estilo cuyo origen se data a comienzos del siglo XX. Nació como oposición al minimalismo entonces reinante. Se caracteriza principalmente por una elegancia atemporal, su exclusividad, carácter decorativo y por una combinación de inspiraciones procedentes de diferentes tipos de ornamentaciones. En un clima glamour todo debe brillar, por ese motivo recomendamos las manillas GLORIA con 9 cristales en color negro o blanco transparente. También serán una buena elección los excepcionales pomos de cristal (negros, transparentes, rosas).

ESTILO RETRO

Una vivienda de los tiempos de la abuela o la bisabuela, con un ligero soplo de modernidad: así podríamos definir brevemente el estilo retro. Aquí funciona todo lo que recuerde a un estilismo de hace varias décadas: cuadros en marcos dorados, relojes de cuco, cortinas pesadas, grandes muebles de madera tapizados, un parqué clásico en el suelo. Con un interior así conjuntan idealmente las manillas RETRO y STILO (con formas de fantasía, en color latón viejo), así como las RODOS, de formas algo más sencillas.

ESTILO LOFT

Los lofts son interiores postindustriales, cuya historia se remonta a alrededor del año 1900. Todo comenzó en París, donde la bohemia local utilizaba antiguas fábricas y almacenes como estudios. Las viviendas en lofts se hi-

cieron populares en los años 60 del siglo XX y desde entonces se relacionan con comodidad diaria, individualismo y libertad creativa. Los lofts destacan principalmente por unas estructuras naturales, crudas, espacios abiertos y un minimalismo industrial. Al elegir unas manillas para ellos merece la pena ver modelos como SILANA con roseta, VERDON con roseta o QUBIK.

ESTILO ESCANDINAVO

Soluciones minimalistas y muy funcionales, materias primas naturales y colores claros: por esto, entre otras cosas, es valorado el estilo escandinavo. Los materiales utilizados en un interior así son ante todo la madera cruda, el lino, el algodón y la lana. Los colores se mantienen en tonos blancos, azules, celestes, verdes botella, así como negros y grises que contrastan con ellos. Se debe recordar también la mayor cantidad posible de iluminación natural. Las manillas que merece la pena considerar al amueblar un interior escandinavo son, entre otras, los modelos satinados y mates IRYS y ASTER, los QUBIK II blancos o negros y MEDA.

ESTILO MARINISTA

El estilo marinista es todo lo que se asocia con el verano junto al mar. El susurro del agua azul, las suaves líneas de las olas, las nubes blancas... Por ese motivo también los interiores marinistas son precisamente colores blancos y azules y todo lo que tiene líneas onduladas, como las que encontramos en las manillas NOA, MALTA o TALIA.

MEET THE KUCHNIOX HANDLES LINE

The Kuchnix brand handle offer includes 3 lines: Economy, Classic and Premium. What is behind these names? What features distinguish each of them?

ECONOMY LINE

Kuchnix Economy Line handles most of all mean simple and functional form. Thanks to this, they are very universal and match almost any interior and kind of door. Equally important here is the price that goes with satisfying quality. Economy models are among others ADA, AGRA or EWA handles

CLASSIC LINE

Classic Line is a classic elegance. Models of this kind are characterized by a delicate, toned design but also large variety of colours. They are easy to match with different interior designs and appreciated for its ergonomics. Classic Line models are among others, ARIA, ASTER, IRYS or GOA handles.

PREMIUM LINE

Premium Line is for those, who love unique design. The variety of used materials, wide range of finishes, impressive patterns and Polish designs are only some of the features these models are appreciated for. Innovative mounting solutions should also be emphasised. Thanks to all this, Premium products satisfy the most sophisticated tastes and guarantee the highest comfort of use. Premium Line models include among others, NERO, PARVA, ROY or TIMOR handles. All our handles are high quality products. The distinction is a result of additional functions or technological solutions.

In the catalogue, the series class marking is presented by means of pictograms.



ADDITIONAL INFORMATION DESIGNATIONS

For the comfort of looking through the catalogue we have put pictograms informing about special features of a product. Using them is easier than standard descriptions.



Polish design



Interesting design



Easy assembly



Installation template included



Compact dimension



Long thread



Warranty - surface mechanism



Warranty - surface mechanism



SAVIO series handle
Türdrücker der Serie SAVIO
Manilla de la serie SAVIO

ENTDECKEN SIE DIE TÜRDRÜCKERLINIE KUCHINOX

Das Angebot an Türdrückern der Marke Kuchinox wird in 3 Linien unterschieden: Economy, Classic und Premium. Was verbirgt sich hinter diesen Namen? Welche Merkmale zeichnen sie jeweils aus?

ECONOMY LINE

Die Türdrücker der Economy Line von Kuchinox sind vor allem einfach und funktionell in ihrer Form. Dadurch sind sie sehr vielseitig und für fast alle Innenräume und Türarten geeignet. Ebenso wichtig ist hier der gute Preis bei gleichzeitig zufriedenstellender Qualität. Zu den Economy-Modellen gehören zum Beispiel die Türdrücker ADA, AGRA oder EWA.

CLASSIC LINE

Die Classic-Linie ist klassische Eleganz. Die Modelle, die unter dieses Banner fallen, haben einen zarten, zurückhaltenden Stil, aber auch eine abwechslungsreiche Farbgebung. Sie lassen sich leicht an verschiedene Arten von Arrangements anpassen und werden auch wegen ihrer Ergonomie geschätzt. Zu den Classic-Modellen gehören unter anderem die Türdrücker ARIA, ASTER, IRYS oder GOA.

PREMIUM LINE

Die Premium-Linie ist etwas für alle, die ein unverwechselbares Design lieben. Die Vielfalt der verwendeten Materialien, die große Auswahl an Ausführungen, die auffälligen Muster und das polnische Design sind nur einige der Merkmale, für die diese Modelle geschätzt werden. Hervorzuheben sind auch die innovativen Montagelösungen. Dank all dem genügen die Premium-Produkte den höchsten Ansprüchen und garantieren höchsten Ge-

brauchskomfort. Zu den Premium-Modellen gehören unter anderem die Türdrücker NERO, PARVA, ROY oder TIMOR. Alle unsere Türdrücker sind qualitativ hochwertige Produkte. Die Unterscheidung basiert auf dem Umfang der zusätzlichen Funktionen und technologischen Lösungen. Im Katalog wird die Kennzeichnung der Serienklasse mit Piktogrammen dargestellt:



ZUSÄTZLICHE INFORMATIVE KENNZEICHNUNGEN

Um das Durchblättern des Katalogs zu erleichtern, haben wir Piktogramme eingefügt, die Informationen über die jeweiligen Produkteigenschaften liefern.

Ihre Verwendung ist einfacher als die von Standardbeschreibungen.



Polnisches Projekt



Interessantes Design



Einfache Montage



Montageschablone im Set enthalten



Kompakte Größe



Verlängertes Gewinde



Garantie Oberfläche Mechanismus



Garantie Oberfläche Mechanismus

CONOCE LAS LÍNEAS DE MANILLAS KUCHINOX

La oferta de manillas de la marca Kuchinox está dividida en 3 líneas: Economy, Classic y Premium. ¿Qué se esconde bajo estos nombres? ¿Qué características distinguen a cada una de ellas?

ECONOMY LINE

Las manillas Kuchinox Economy Line son ante todo una forma sencilla y funcional. Gracias a esto son muy universales y conjuntan con prácticamente cualquier interior y tipo de puerta. También es aquí importante un buen precio y al mismo tiempo una calidad satisfactoria. Entre los modelos Economy incluimos, por ejemplo, las manillas ADA, AGRA o EWA.

CLASSIC LINE

La línea Classic es una elegancia clásica. Los modelos de esta línea tienen un estilo delicado y armonioso, pero también colores variados. Es fácil conjuntarlos con diferentes tipos de decoraciones, también son valorados por su ergonomía. Entre los modelos Classic incluimos, por ejemplo, las manillas ARIA, ASTER, IRYS o GOA.

PREMIUM LINE

La línea Premium es algo para aquellos a los que les gusta un diseño único. La diversidad de materiales empleados, una gama muy amplia de acabados, modelos llamativos y diseños polacos son solo algunas de las características por las que son valorados estos modelos. También se deben destacar las innovadoras soluciones de montaje. Gracias a esto todos los productos Premium satisfacen los gustos más refinados y garantizan la mayor comodidad de uso. Entre los modelos Premium incluimos, por ejemplo, las manillas NERO, PARVA, ROY o TIMOR.

Todas nuestras manillas son productos de elevada calidad. La diferenciación se debe al alcance de las funciones adicionales o soluciones tecnológicas.

En el catálogo la indicación de la clase de las series ha sido presentada mediante pictogramas:



INFORMACIÓN ADICIONAL

Para una mayor comodidad al ver el catálogo hemos introducido pictogramas que informan de las características detalladas del producto. Su uso es más sencillo que el de las descripciones estándar.



Diseño polaco



Diseño interesante



De fácil instalación



Plantilla de montaje incluida



Tamaño compacto



Rosca extendida



Garantía de la superficie del mecanismo



Garantía de la superficie del mecanismo

KUCHINOX

INSPIRATION COMES FROM THE INSIDE

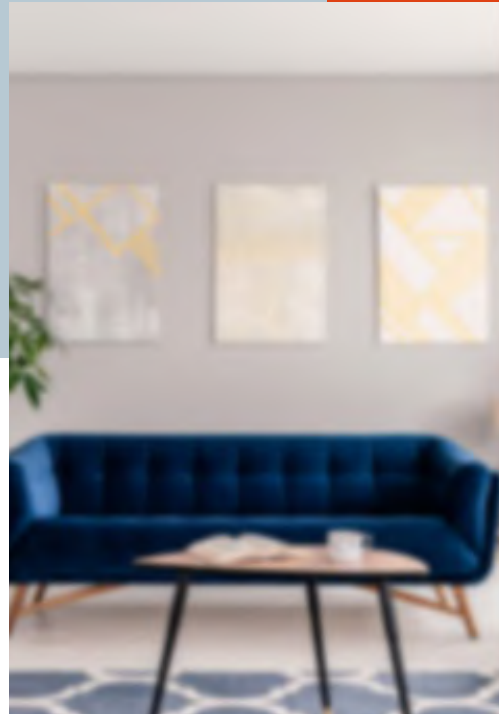

HANDLES WITH SPLIT PLATE
TÜRDRÜCKER AUF GETEILTEM SCHILD
MANILLAS CON ROSETA



ARIA II

Handle with a square split plate
Türdrücker auf geteiltem quadratischem Schild
Manilla con roseta cuadrada



Key
Schlüssel
Llave
LK4_101S



Insert
Zylindereinsatz
Cilindro
LK4_102S



Toilet
WC
LK4_103S

KA2_100A



satin | satén / chrome | chrom | cromo
EAN: 5907791124272



Key
Schlüssel
Llave
LK4_401S



Insert
Zylindereinsatz
Cilindro
LK4_402S



Toilet
WC
LK4_403S

KA2_400A



patina | pátina
EAN: 5907791124869



GLORIA

Handle with a square split plate
Türdrücker auf geteiltem quadratischem Schild
Manilla con roseta cuadrada



Key
Schlüssel
Llave
LK2_001B



Insert
Zylindereinsatz
Cilindro
LK2_002B



Toilet
WC
LK2_003B

KLO_000A



chrome | chrom | cromo
EAN: 5907791113498



Key
Schlüssel
Llave
LK2_001B



Insert
Zylindereinsatz
Cilindro
LK2_002B



Toilet
WC
LK2_003B

KLO_000B



chrome | chrom | cromo
EAN: 5907791115157

NEW
NEUHEIT
NOVEDAD



KLO_900A



black | schwarz | negro
EAN: 5907791184238



Key
Schlüssel
Llave
LK2_901A

Insert
Zylindereinsatz
Cilindro
LK2_902A

Toilet
WC
LK2_903A



GLORIA series handle
Türdrücker der Serie GLORIA
Manilla de la serie GLORIA



LUGA

Handle with a square split plate
Türdrücker auf geteiltem quadratischem Schild
Manilla con roseta cuadrada



KSL_100A



satin | satén / chrome | chrom | cromo
EAN: 5907791115898



Key
Schlüssel
Llave
LK4_101S
Insert
Zylindereinsatz
Cilindro
LK4_102S
Toilet
WC
LK4_103S



LUXOR II

Handle with a square split plate
Türdrücker auf geteiltem quadratischem Schild
Manilla con roseta cuadrada



KL2_100A



satin | satén / chrome | chrom | cromo
EAN: 5907791124289



Key
Schlüssel
Llave
LK4_101S
Insert
Zylindereinsatz
Cilindro
LK4_102S
Toilet
WC
LK4_103S



KGD_100A



satin | satén / chrome | chrom | cromo
EAN: 5906775348338



**Key
Schlüssel
Llave**
LK4_101S



**Insert
Zylindereinsatz
Cilindro**
LK4_102S



**Toilet
WC**
LK4_103S



KGD_400A



patina | pátina
EAN: 5906775348383



**Key
Schlüssel
Llave**
LK4_401S



**Insert
Zylindereinsatz
Cilindro**
LK4_402S



**Toilet
WC**
LK4_403S



KGD_500A



graphite | graphit | grafito / chrome | chrom | cromo
EAN: 5907791125095



**Key
Schlüssel
Llave**
LK4_501A



**Insert
Zylindereinsatz
Cilindro**
LK4_502A



**Toilet
WC**
LK4_503A



NERO

Handle with a square split plate
Türdrücker auf geteiltem quadratischem Schild
Manilla con roseta cuadrada



KNE_300A



satin | satén
EAN: 5907791123596



Key
Schlüssel
Llave
LK5_301A



Insert
Zylindereinsatz
Cilindro
LK5_302A



Toilet
WC
LK5_303A



KNE_500A



graphite | graphit | grafito / chrome | chrom | cromo
EAN: 5907791124210



Key
Schlüssel
Llave
LK5_501A



Insert
Zylindereinsatz
Cilindro
LK5_502A



Toilet
WC
LK5_503A



NERO series handle
Türdrücker der Serie NERO
Manilla de la serie NERO

PARVA

Handle with a square split plate
Türdrücker auf geteiltem quadratischem Schild
Manilla con roseta cuadrada



PARVA series handle
Türdrücker der Serie PARVA
Manilla de la serie PARVA



KRV_000A

● chrome | chrom | cromo
EAN: 5907791124227



**Key
Schlüssel
Llave**

LK5_001A



**Insert
Zylindereinsatz
Cilindro**

LK5_002A



**Toilet
WC**

LK5_003A



KRV_100A

● satin | satén / chrome | chrom | cromo
EAN: 5907791122155



**Key
Schlüssel
Llave**

LK2_001B



**Insert
Zylindereinsatz
Cilindro**

LK2_002B



**Toilet
WC**

LK2_003B



PARVA

Handle with a square split plate
Türdrücker auf geteiltem quadratischem Schild
Manilla con roseta cuadrada



KRV_300A



satin | satén
EAN: 5907791141347



Key
Schlüssel
Llave
LK5_301A



Insert
Zylindereinsatz
Cilindro
LK5_302A



Toilet
WC
LK5_303A



KRV_900A



black | schwarz | negro
EAN: 5907791105233



Key
Schlüssel
Llave
LK5_901A



Insert
Zylindereinsatz
Cilindro
LK5_902A



Toilet
WC
LK5_903A



PARVA series handle
Türdrücker der Serie PARVA
Manilla de la serie PARVA

PRIMA

Handle with a square split plate
Türdrücker auf geteiltem quadratischem Schild
Manilla con roseta cuadrada



PRIMA series handle
Türdrücker der Serie PRIMA
Manilla de la serie PRIMA



Key
Schlüssel
Llave
LK2_101B



Insert
Zylindereinsatz
Cilindro
LK2_102B



Toilet
WC
LK2_103B

KPR_100A



satin | satén / chrome | chrom | cromo
EAN: 5907791132529



QUBIK II

Handle with a square split plate
Türdrücker auf geteiltem quadratischem Schild
Manilla con roseta cuadrada

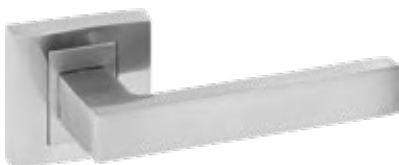

KG2_300A



satin | satén
EAN: 5907791127792



Key
Schlüssel
Llave
LK5_301A



Insert
Zylindereinsatz
Cilindro
LK5_302A



Toilet
WC
LK5_303A



KG2_600A



white | weiß | blanco
EAN: 5907791104212



Key
Schlüssel
Llave
LK5_601A



Insert
Zylindereinsatz
Cilindro
LK5_602A



Toilet
WC
LK5_603A



KG2_800A



rose gold | roségold | oro rosa
EAN: 5907791182128



Key
Schlüssel
Llave
LK5_801A



Insert
Zylindereinsatz
Cilindro
LK5_802A



Toilet
WC
LK5_803A



KG2_900A



black | schwarz | negro
EAN: 5907791104298



Key
Schlüssel
Llave
LK5_901A



Insert
Zylindereinsatz
Cilindro
LK5_902A



Toilet
WC
LK5_903A

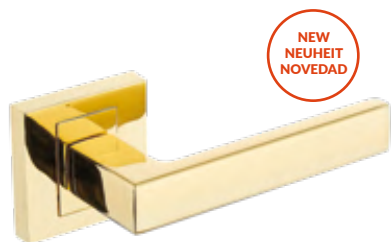

NEW
NEUHEIT
NOVEDAD

KG2_G00A



gold | dorado
EAN: 5907791182135



Key
Schlüssel
Llave
LK5_G01A



Insert
Zylindereinsatz
Cilindro
LK5_G02A



Toilet
WC
LK5_G03A

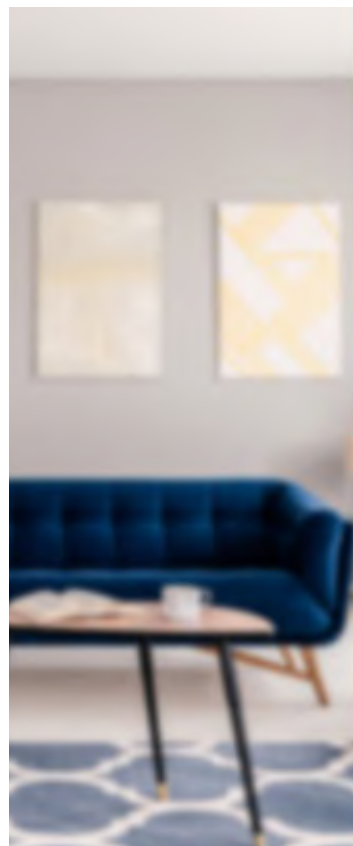

QUBIK II series handle
Türdrücker der Serie QUBIK II
Manilla de la serie QUBIK II



ROY

Handle with a square split plate
Türdrücker auf geteiltem quadratischem Schild
Manilla con roseta cuadrada



KRO_100A



satin | satén / chrome | chrom | cromo
EAN: 5907791123619



Key
Schlüssel
Llave
LK5_101A



Insert
Zylindereinsatz
Cilindro
LK5_102A



Toilet
WC
LK5_103A



ROY series handle
Türdrücker der Serie ROY
Manilla de la serie ROY



SAVIO series handle
 Türdrücker der Serie SAVIO
 Manilla de la serie SAVIO



Key
Schlüssel
Llave
 LK5_001A



Insert
Zylindereinsatz
Cilindro
 LK5_002A



Toilet
WC
 LK5_003A

KSO_00B



chrome | chrom | cromo / black | schwarz | negro
 EAN: 5907791140227



Key
Schlüssel
Llave
 LK5_301A



Insert
Zylindereinsatz
Cilindro
 LK5_302A



Toilet
WC
 LK5_303A

KSO_30B



satin | satén / black | schwarz | negro
 EAN: 5907791140241



SAVIO

Handle with a square split plate
Türdrücker auf geteiltem quadratischem Schild
Manilla con roseta cuadrada



KSO_000W



chrome | chrom | cromo / white | weiß | blanco
EAN: 5907791140210



Key
Schlüssel
Llave
LK5_001A



Insert
Zylindereinsatz
Cilindro
LK5_002A



Toilet
WC
LK5_003A



KSO_300W



satin | satén / white | weiß | blanco
EAN: 5907791140234



Key
Schlüssel
Llave
LK5_301A



Insert
Zylindereinsatz
Cilindro
LK5_302A



Toilet
WC
LK5_303A



SAVIO series handle
Türdrücker der Serie SAVIO
Manilla de la serie SAVIO



SILANA series handle
Türdrücker der Serie SILANA
Manilla de la serie SILANA



KSI_300A

● satin | satén
EAN: 5907791183330



Key
Schlüssel
Llave
LK1_301S



Insert
Zylindereinsatz
Cilindro
LK1_302S



Toilet
WC
LK1_303S



KSI_900A

● black | schwarz | negro
EAN: 5907791183347



Key
Schlüssel
Llave
LK1_901A



Insert
Zylindereinsatz
Cilindro
LK1_902A



Toilet
WC
LK1_903A



TALIA

Handle with a square split plate
Türdrücker auf geteiltem quadratischem Schild
Manilla con roseta cuadrada



KWT_100S



satin | satén / chrome | chrom | cromo
EAN: 5907791112514



Key
Schlüssel
Llave
LK4_101S



Insert
Zylindereinsatz
Cilindro
LK4_102S



Toilet
WC
LK4_103S



TIMOR

Handle with a square split plate
Türdrücker auf geteiltem quadratischem Schild
Manilla con roseta cuadrada



KMT_100A



satin | satén / chrome | chrom | cromo
EAN: 5907791121530



Key
Schlüssel
Llave
LK4_101S



Insert
Zylindereinsatz
Cilindro
LK4_102S



Toilet
WC
LK4_103S



AREUS series handle
 Türdrücker der Serie AREUS
 Manilla de la serie AREUS



KRE_300A

● satin | satén
 EAN: 5907791188526



Key
 Schlüssel
 Llave
 LK1_301S



Insert
 Zylindereinsatz
 Cilindro
 LK1_302S



Toilet
 WC
 LK1_303S



KRE_900A

● black | schwarz | negro
 EAN: 5907791188533



Key
 Schlüssel
 Llave
 LK1_901A



Insert
 Zylindereinsatz
 Cilindro
 LK1_902A



Toilet
 WC
 LK1_903A



BINGO

Handle with a square split plate
Türdrücker auf geteiltem quadratischem Schild
Manilla con roseta cuadrada



KGB_300A



satin | satén
EAN: 5906775346839



Key
Schlüssel
Llave
LK1_301S
Insert
Zylindereinsatz
Cilindro
LK1_302S
Toilet
WC
LK1_303S



IWA

Handle with a square split plate
Türdrücker auf geteiltem quadratischem Schild
Manilla con roseta cuadrada

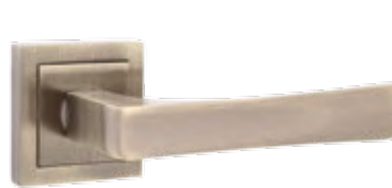

KWA_400A



patina | pátina
EAN: 5907791125194



Key
Schlüssel
Llave
LK2_401B
Insert
Zylindereinsatz
Cilindro
LK2_402B
Toilet
WC
LK2_403B

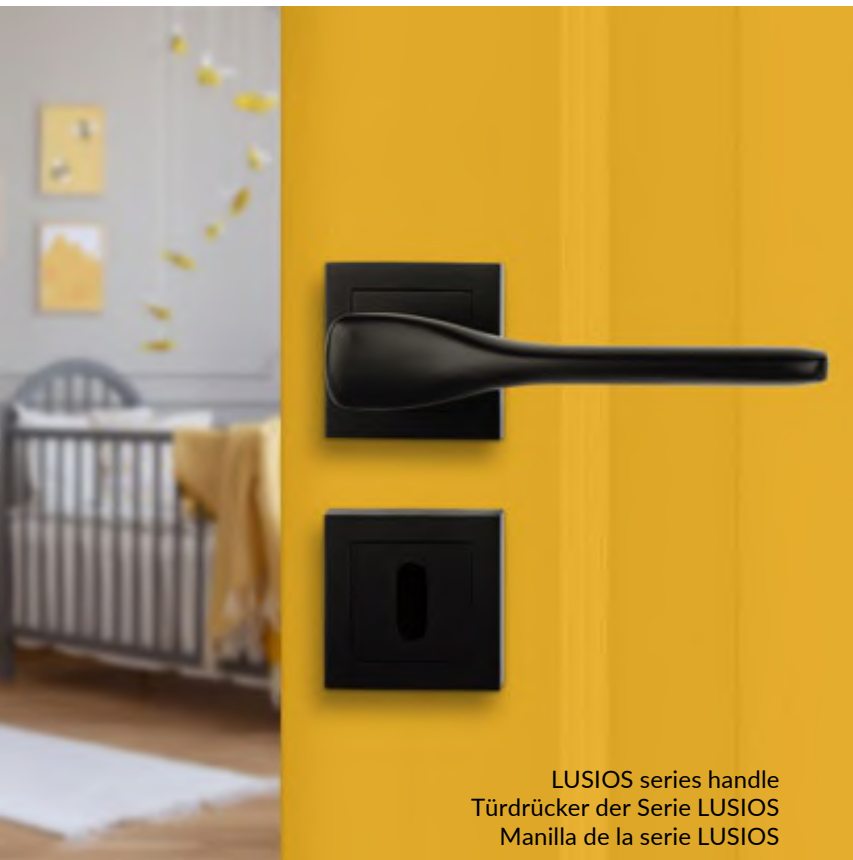

LUSIOS series handle
Türdrücker der Serie LUSIOS
Manilla de la serie LUSIOS



KLS_300A

● satin | satén
EAN: 5907791188069



Key
Schlüssel
Llave
LK2_301B



Insert
Zylindereinsatz
Cilindro
LK2_302B



Toilet
WC
LK2_303B



KLS_900A

● black | schwarz | negro
EAN: 5907791188076



Key
Schlüssel
Llave
LK2_901A



Insert
Zylindereinsatz
Cilindro
LK2_902A



Toilet
WC
LK2_903A



QUBIK

Handle with a square split plate
Türdrücker auf geteiltem quadratischem Schild
Manilla con roseta cuadrada

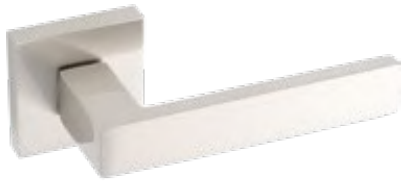

KGQ_300A



satin | satén
EAN: 5907791110169



Key
Schlüssel
Llave
LK1_301S



Insert
Zylindereinsatz
Cilindro
LK1_302S



Toilet
WC
LK1_303S



KGQ_400A



patina | pátina
EAN: 5907791111616



Key
Schlüssel
Llave
LK1_401S



Insert
Zylindereinsatz
Cilindro
LK1_402S



Toilet
WC
LK1_403S



RANDO

Handle with a square split plate
Türdrücker auf geteiltem quadratischem Schild
Manilla con roseta cuadrada



KRA_900A



black | schwarz | negro
EAN: 5907791141910



Key
Schlüssel
Llave
LK2_901A



Insert
Zylindereinsatz
Cilindro
LK2_902A



Toilet
WC
LK2_903A



SAMARIA series handle
Türdrücker der Serie SAMARIA
Manilla de la serie SAMARIA



KAM_300A

● satin | satén
EAN: 5907791188083



Key
Schlüssel
Llave
LK2_301B
Insert
Zylindereinsatz
Cilindro
LK2_302B
Toilet
WC
LK2_303B



KAM_900A

● black | schwarz | negro
EAN: 5907791188090



Key
Schlüssel
Llave
LK2_901A
Insert
Zylindereinsatz
Cilindro
LK2_902A
Toilet
WC
LK2_903A



VERA

Handle with a square split plate
Türdrücker auf geteiltem quadratischem Schild
Manilla con roseta cuadrada



KVE_900A



black | schwarz | negro
EAN: 5907791158963



Key
Schlüssel
Llave
LK1_901A
Insert
Zylindereinsatz
Cilindro
LK1_902A
Toilet
WC
LK1_903A



ELIKA

Handle with a round split plate
Türdrücker auf geteiltem rundem Schild
Manilla con roseta redonda



KAE_600A



chrome | chrom | cromo / white | weiß | blanco
EAN: 5907791105356



Key
Schlüssel
Llave
LO1_001S
Insert
Zylindereinsatz
Cilindro
LO1_002S
Toilet
WC
LO1_003S



KAE_800W



rose gold | roségold | oro rosa / white | weiß | blanco
EAN: 5907791182159



Key
Schlüssel
Llave
LO1_801A
Insert
Zylindereinsatz
Cilindro
LO1_802A
Toilet
WC
LO1_803A

NEW
NEUHEIT
NOVEDAD



KAE_800B

rose gold | roségold | oro rosa / black | schwarz | negro
EAN: 5907791182142



Key
Schlüssel
Llave
LO1_801A



Insert
Zylindereinsatz
Cilindro
LO1_802A



Toilet
WC
LO1_803A



KAE_900A

chrome | chrom | cromo / black | schwarz | negro
EAN: 5907791105691



Key
Schlüssel
Llave
LO1_001S



Insert
Zylindereinsatz
Cilindro
LO1_002S



Toilet
WC
LO1_003S

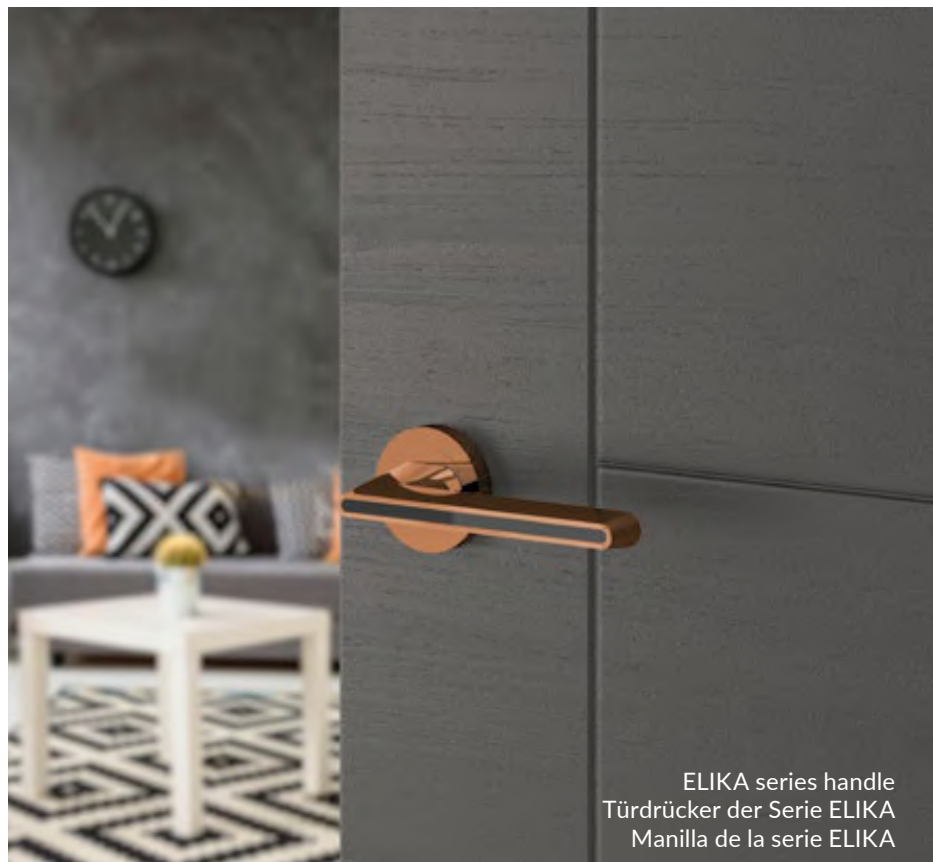

ELIKA series handle
Türdrücker der Serie ELIKA
Manilla de la serie ELIKA



ELIKA

Handle with a round split plate
Türdrücker auf geteiltem quadratischem Schild
Manilla con roseta redonda



NEW
NEUHEIT
NOVEDAD

KAE_G00B



gold | dorado / black | schwarz | negro
EAN: 5907791182166



Key
Schlüssel
Llave
LO1_G01A



Insert
Zylindereinsatz
Cilindro
LO1_G02A



Toilet
WC
LO1_G03A



NEW
NEUHEIT
NOVEDAD

KAE_G00W



gold | dorado / white | weiß | blanco
EAN: 5907791182173



Key
Schlüssel
Llave
LO1_G01A



Insert
Zylindereinsatz
Cilindro
LO1_G02A



Toilet
WC
LO1_G03A



CRYSTAL DOORKNOBS |

Crystal doorknob with a round split plate
Kristallknauf auf geteiltem rundem Schild
Pomos de cristal con roseta redonda



KTK_090A



chrome | chrom | cromo
EAN: 5907791128799



Key
Schlüssel
Llave
LO1_001S



Insert
Zylindereinsatz
Cilindro
LO1_002S



Toilet
WC
LO1_003S



KTK_09NP



chrome | chrom | cromo
EAN: 5907791144829



Key
Schlüssel
Llave
LO1_001S



Insert
Zylindereinsatz
Cilindro
LO1_002S



Toilet
WC
LO1_003S

KRISTALLKNÄUFE | POMOS DE CRISTAL



KTK_09NB

chrome | chrom | cromo
EAN: 5907791144812



KTK_39NA

satin | satén
EAN: 5907791144836



Key
Schlüssel
Llave
LO1_001S



Insert
Zylindereinsatz
Cilindro
LO1_002S



Toilet
WC
LO1_003S



Key
Schlüssel
Llave
LO1_301S



Insert
Zylindereinsatz
Cilindro
LO1_302S



Toilet
WC
LO1_303S



CRYSTAL DOORKNOB
KRISTALLKNÄUFE
POMO DE CRISTAL





TARA

Handle with a round split plate
Türdrücker auf geteiltem quadratischem Schild
Manilla con roseta redonda



KAT_600A



chrome | chrom | cromo / white | weiß | blanco
EAN: 5907791105332



Key
Schlüssel
Llave
LO1_001S



Insert
Zylindereinsatz
Cilindro
LO1_002S



Toilet
WC
LO1_003S



KAT_900A



chrome | chrom | cromo / black | schwarz | negro
EAN: 5907791105684



Key
Schlüssel
Llave
LO1_001S



Insert
Zylindereinsatz
Cilindro
LO1_002S



Toilet
WC
LO1_003S



TARA series handle
Türdrücker der Serie TARA
Manilla de la serie TARA



VERDON series handle
Türdrücker der Serie VERDON
Manilla de la serie VERDON



Key
Schlüssel
Llave
LO1_3M1A



Insert
Zylindereinsatz
Cilindro
LO1_3M2A



Toilet
WC
LO1_3M3A

KVR_3M0A



matte satin | satin matt | satén mate
EAN: 5907791187291



Key
Schlüssel
Llave
LO1_921A



Insert
Zylindereinsatz
Cilindro
LO1_922A



Toilet
WC
LO1_923A

KVR_900A



black | schwarz | negro
EAN: 5907791187284



ANDA

Handle with a round split plate
Türdrücker auf geteiltem quadratischem Schild
Manilla con roseta redonda



KAN_300A



satin | satén
EAN: 5907791141323



Key
Schlüssel
Llave
LO1_301S



Insert
Zylindereinsatz
Cilindro
LO1_302S



Toilet
WC
LO1_303S



ARIA

Handle with a round split plate
Türdrücker auf geteiltem quadratischem Schild
Manilla con roseta redonda



KAR_300A



satin | satén
EAN: 5907791132437



Key
Schlüssel
Llave
LO1_301S



Insert
Zylindereinsatz
Cilindro
LO1_302S



Toilet
WC
LO1_303S



KAR_400A



patina | pátina
EAN: 5907791132475



Key
Schlüssel
Llave
LO1_401S



Insert
Zylindereinsatz
Cilindro
LO1_402S



Toilet
WC
LO1_403S

ASTER

Handle with a round split plate
Türdrücker auf geteiltem quadratischem Schild
Manilla con roseta redonda



KAS_3M0A



matte satin | satin matt | satén mate
EAN: 5907791124593



Key
Schlüssel
Llave
LO1_3M1S



Insert
Zylindereinsatz
Cilindro
LO1_3M2S



Toilet
WC
LO1_3M3S



KAS_4M0A



matte patina | patina matt | pátina mate
EAN: 5907791124630



Key
Schlüssel
Llave
LO1_4M1A



Insert
Zylindereinsatz
Cilindro
LO1_4M2A



Toilet
WC
LO1_4M3A

AURA

Handle with a round split plate
Türdrücker auf geteiltem quadratischem Schild
Manilla con roseta redonda



KSA_300A



satin | satén
EAN: 5906775346549



Key
Schlüssel
Llave
LO1_301S



Key
Schlüssel
llave
LO1_302S



Toilet
WC
LO1_303S



DONA

Handle with a round split plate
Türdrücker auf geteiltem quadratischem Schild
Manilla con roseta redonda



KDO_300A



satin | satén
EAN: 5907791123435



Key
Schlüssel
Llave
LO1_301S



Insert
Zylindereinsatz
Cilindro
LO1_302S



Toilet
WC
LO1_303S



DUET

Handle with a round split plate
Türdrücker auf geteiltem quadratischem Schild
Manilla con roseta redonda



KDU_100A



satin | satén / chrome | chrom | cromo
EAN: 5907791130136



Key
Schlüssel
Llave
LO1_101S



Insert
Zylindereinsatz
Cilindro
LO1_102S



Toilet
WC
LO1_103S

GEMELA

Handle with a round split plate
Türdrücker auf geteiltem quadratischem Schild
Manilla con roseta redonda



KEM_100A



satin | satén / chrome | chrom | cromo
EAN: 5907791130143



Key
Schlüssel
Llave
LO1_101S



Insert
Zylindereinsatz
Cilindro
LO1_102S



Toilet
WC
LO1_103S

GOA

Handle with a round split plate
Türdrücker auf geteiltem quadratischem Schild
Manilla con roseta redonda



KCG_300A



satin | satén
EAN: 5907791111333



Key
Schlüssel
Llave
LO1_301S



Insert
Zylindereinsatz
Cilindro
LO1_302S



Toilet
WC
LO1_303S



KCG_400A



patina | pátina
EAN: 5907791111388



Key
Schlüssel
Llave
LO1_401S



Insert
Zylindereinsatz
Cilindro
LO1_402S



Toilet
WC
LO1_403S



IRYS

Handle with a round split plate
Türdrücker auf geteiltem quadratischem Schild
Manilla con roseta redonda



KCI_3M0A



matte satin | satin matt | satén mate
EAN: 5907791110060



Key
Schlüssel
Llave
LO1_3M



Insert
Zylindereinsatz
Cilindro
LO1_3M2S



Toilet
WC
LO1_3M3S



LUGA II

Handle with a round split plate
Türdrücker auf geteiltem quadratischem Schild
Manilla con roseta redonda



KS2_900A



black | schwarz | negro
EAN: 5907791188540



Key
Schlüssel
Llave
LO1_911A



Insert
Zylindereinsatz
Cilindro
LO1_912A



Toilet
WC
LO1_913A

LUXOR

Handle with a round split plate
Türdrücker auf geteiltem quadratischem Schild
Manilla con roseta redonda



MALTA

Handle with a round split plate
Türdrücker auf geteiltem quadratischem Schild
Manilla con roseta redonda



KLU_100A



satin | satén / chrome | chrom | cromo
EAN: 5907791139016



**Key
Schlüssel
Llave**
LO1_101S



**Insert
Zylindereinsatz
Cilindro**
LO1_102S



**Toilet
WC**
LO1_103S



KLM_3M0A



matte satin | satin matt | satén mate
EAN: 5907791110176



**Key
Schlüssel
Llave**
LO1_3M1S



**Insert
Zylindereinsatz
Cilindro**
LO1_3M2S



**Toilet
WC**
LO1_3M3S



KLM_400A



patina | pátina
EAN: 5907791110220



**Key
Schlüssel
Llave**
LO1_401S



**Insert
Zylindereinsatz
Cilindro**
LO1_402S



**Toilet
WC**
LO1_403S



MARIO

Handle with a round split plate
Türdrücker auf geteiltem quadratischem Schild
Manilla con roseta redonda



KSM_300S

 satin | satén
EAN: 5907791111814



Key
Schlüssel
Llave
LO2_301S



Insert
Zylindereinsatz
Cilindro
LO2_302S



Toilet
WC
LO2_303S



KSM_400S

 patina | pátina
EAN: 5907791111869



Key
Schlüssel
Llave
LO2_401S



Insert
Zylindereinsatz
Cilindro
LO2_402S



Toilet
WC
LO2_403S



MARS

Handle with a round split plate
Türdrücker auf geteiltem quadratischem Schild
Manilla con roseta redonda



KCM_100A

 satin | satén / chrome | chrom | cromo
EAN: 5906775344651



Key
Schlüssel
Llave
LO1_101S



Insert
Zylindereinsatz
Cilindro
LO1_102S



Toilet
WC
LO1_103S



KCR_390A

 satin | satén
EAN: 5906775348567



KCR_400A

 patina | pátina
EAN: 5906775344842



KCR_490A

 patina | pátina
EAN: 5906775348550





RODOS

Handle with a round split plate
Türdrücker auf geteiltem quadratischem Schild
Manilla con roseta redonda



KGO_400A



patina | pátina
EAN: 5906775348628



Key
Schlüssel
Llave
LO2_401S



Insert
Zylindereinsatz
Cilindro
LO2_402S



Toilet
WC
LO2_403S



STILO

Handle with a round split plate
Türdrücker auf geteiltem quadratischem Schild
Manilla con roseta redonda



KCS_400A



patina | pátina
EAN: 5906775347218



Key
Schlüssel
Llave
LO2_401S



Insert
Zylindereinsatz
Cilindro
LO2_402S



Toilet
WC
LO2_403S

ADA

Handle with a round split plate
Türdrücker auf geteiltem quadratischem Schild
Manilla con roseta redonda



AGRA

Handle with a round split plate
Türdrücker auf geteiltem quadratischem Schild
Manilla con roseta redonda



KAD_300A



satin | satén
EAN: 5907791113405



Key
Schlüssel
Llave
LO1_301S



Insert
Zylindereinsatz
Cilindro
LO1_302S



Toilet
WC
LO1_303S



KAG_300A



satin | satén
EAN: 5907791122889



Key
Schlüssel
Llave
LO1_301S



Insert
Zylindereinsatz
Cilindro
LO1_302S



Toilet
WC
LO1_303S



KAG_400A



patina | pátina
EAN: 5907791126245



Key
Schlüssel
Llave
LO1_401S



Insert
Zylindereinsatz
Cilindro
LO1_402S



Toilet
WC
LO1_403S



EWA

Handle with a round split plate
Türdrücker auf geteiltem quadratischem Schild
Manilla con roseta redonda



KEW_300A



satin | satén
EAN: 5907791123473



Key
Schlüssel
Llave
LO3_301A



Insert
Zylindereinsatz
Cilindro
LO3_302A



Toilet
WC
LO3_303A



NOA

Handle with a round split plate
Türdrücker auf geteiltem quadratischem Schild
Manilla con roseta redonda



KNA_300A



satin | satén
EAN: 5907791112576



Key
Schlüssel
Llave
LO1_301S



Insert
Zylindereinsatz
Cilindro
LO1_302S



Toilet
WC
LO1_303S



KNA_400A



patina | pátina
EAN: 5907791112897



Key
Schlüssel
Llave
LO1_401S



Insert
Zylindereinsatz
Cilindro
LO1_402S



Toilet
WC
LO1_403S

STANDARD

Handle with a round split plate
Türdrücker auf geteiltem quadratischem Schild
Manilla con roseta redonda



Key
Schlüssel
Llave
LO1_301S



Insert
Zylindereinsatz
Cilindro
LO1_302S



Toilet
WC
LO1_303S

KST_300A



satin | satén
EAN: 5907791124784

KUCHINOX

INSPIRATION COMES FROM THE INSIDE



STAINLESS STEEL HANDLES
TÜRDRÜCKER AUS ROSTFREIEM STAHL
MANILLAS DE ACERO INOXIDABLE



FARO

Stainless steel handle
Türdrücker aus rostfreiem Stahl
Manilla de acero inoxidable



Key
Schlüssel
Llave
LO1_201S
Insert
Zylindereinsatz
Cilindro
LO1_202S
Toilet
WC
LO1_203S

KGF_200A



Stainless steel | rostfreier Stahl | acero inoxidable
EAN: 5906775344798



Key
Schlüssel
Llave
LO1_901A
Insert
Zylindereinsatz
Cilindro
LO1_902A
Toilet
WC
LO1_903A

KGF_900A



black | schwarz | negro
EAN: 5907791165404



LAGOS

Stainless steel handle
Türdrücker aus rostfreiem Stahl
Manilla de acero inoxidable



Key
Schlüssel
Llave
LO1_201S
Insert
Zylindereinsatz
Cilindro
LO1_202S
Toilet
WC
LO1_203S

KGL_200A



Stainless steel | rostfreier Stahl | acero inoxidable
EAN: 5906775344781



Key
Schlüssel
Llave
LO1_901A
Insert
Zylindereinsatz
Cilindro
LO1_902A
Toilet
WC
LO1_903A

KGL_900A



black | schwarz | negro
EAN: 5907791165916



**Key
Schlüssel
Llave**
LK2_201A



**Insert
Zylindereinsatz
Cilindro**
LK2_202A



**Toilet
WC**
LK2_203A

KGM_200A

Stainless steel | rostfreier Stahl | acero inoxidable
EAN: 5907791113115



**Key
Schlüssel
Llave**
LK2_921A



**Insert
Zylindereinsatz
Cilindro**
LK2_922A



**Toilet
WC**
LK2_923A

KGM_900A

black | schwarz | negro
EAN: 5907791165930



PORTO

Stainless steel handle
Türdrücker aus rostfreiem Stahl
Manilla de acero inoxidable



Key
Schlüssel
Llave
LO1_201S



Insert
Zylindereinsatz
Cilindro
LO1_202S



Toilet
WC
LO1_203S

KGP_200A



Stainless steel | rostfreier Stahl | acero inoxidable
EAN: 5906775344804



WIGO

Stainless steel handle
Türdrücker aus rostfreiem Stahl
Manilla de acero inoxidable



WIGO series handle
Türdrücker der Serie WIGO
Manilla de la serie WIGO

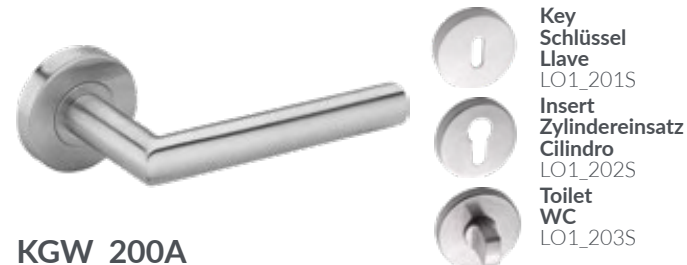

KGW_200A

Stainless steel | rostfreier Stahl | acero inoxidable
EAN: 5907791113368



KGW_900A

black | schwarz | negro
EAN: 5907791165923

KUCHINOX

INSPIRATION COMES FROM THE INSIDE



HANDLES WITH A LONG PLATE
TÜRDRÜCKER AUF LANGSCHILD
MANILLAS CON PLACA



ADA

Handle with a long plate
Türdrücker auf Langschild
Manilla con placa



AGRA

Handle with a long plate
Türdrücker auf Langschild
Manilla con placa

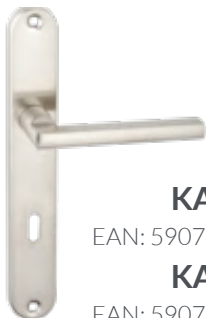

KAD_311A

EAN: 5907791113412



KAD_316A

EAN: 5907791118219



satin | satén

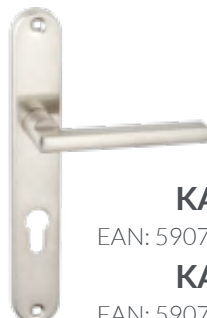

KAD_312A

EAN: 5907791113429



KAD_315A

EAN: 5907791118202



satin | satén

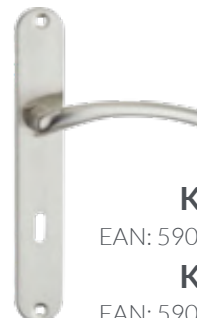

KAG_311A

EAN: 5907791122896



KAG_316A

EAN: 5907791118233



satin | satén

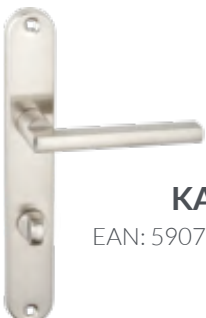

KAD_313A

EAN: 5907791113436



satin | satén

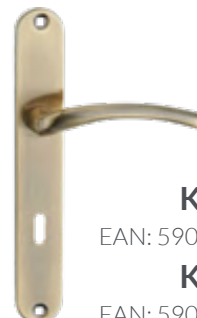

KAG_411A

EAN: 5907791126252



KAG_416A

EAN: 5907791118653



patina | pátina

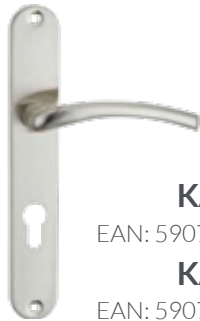

KAG_312A

EAN: 5907791122902



KAG_315A

EAN: 5907791118226



satin | satén

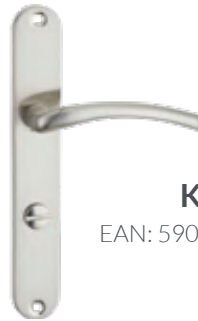

KAG_313A

EAN: 5907791122919



satin | satén

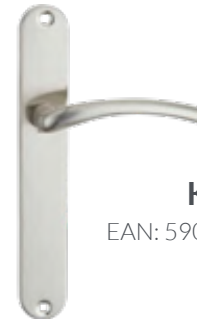

KAG_314A

EAN: 5907791126238



satin | satén

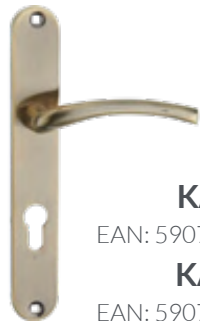

KAG_412A

EAN: 5907791126269



KAD_415A

EAN: 5907791118240



patina | pátina

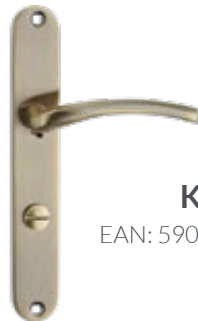

KAG_413A

EAN: 5907791126276



patina | pátina

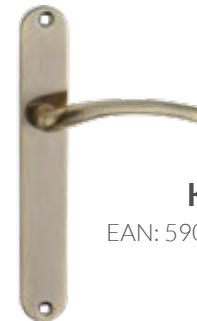

KAG_414A

EAN: 5907791126283



patina | pátina



ARIA

Handle with a long plate
Türdrücker auf Langschild
Manilla con placa

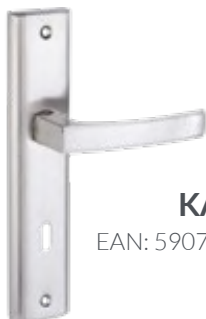

KAR_311A

EAN: 5907791132444



satin | satén

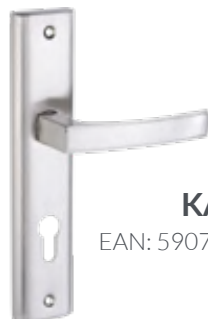

KAR_312A

EAN: 5907791132451



satin | satén

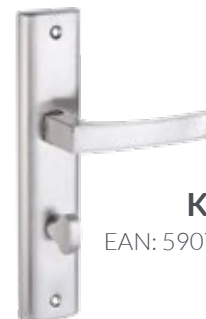

KAR_313A

EAN: 5907791132468



satin | satén

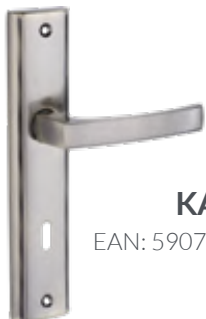

KAR_411A

EAN: 5907791132482



patina | pátina

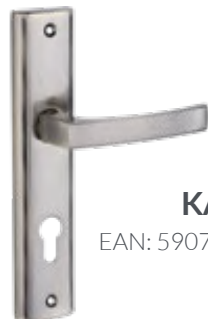

KAR_412A

EAN: 5907791132499



patina | pátina

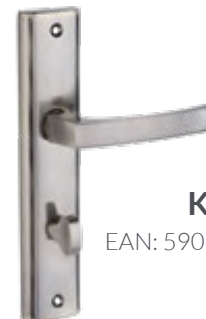

KAR_413A

EAN: 5907791132505



patina | pátina



ASTER

Handle with a long plate
Türdrücker auf Langschild
Manilla con placa

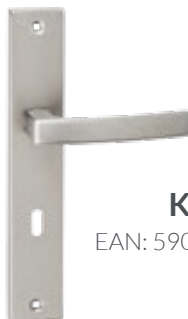

KAS_3M1A

EAN: 5907791124609



matte satin | satin matt | satén mate

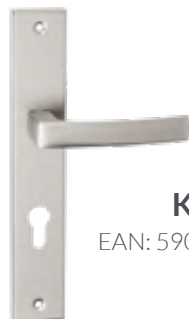

KAS_3M2A

EAN: 5907791124616



matte satin | satin matt | satén mate



KAS_3M3A

EAN: 5907791124623



matte satin | satin matt | satén mate



KAS_3M4A

EAN: 5907791128171



matte satin | satin matt | satén mate



AURA

Handle with a long plate
Türdrücker auf Langschild
Manilla con placa



KSA_311A

EAN: 5906775346556



satin | satén



KSA_312A

EAN: 5906775346563



satin | satén



KSA_313A

EAN: 5906775346570



satin | satén



BINGO

Handle with a long plate
Türdrücker auf Langschild
Manilla con placa



KGB_311A

EAN: 5906775346846



satin | satén



KGB_312A

EAN: 5906775346853



satin | satén



KGB_313A

EAN: 5906775346860



satin | satén



KGB_314A

EAN: 5906775346877



satin | satén



EWA

Handle with a long plate
Türdrücker auf Langschild
Manilla con placa



GOA

Handle with a long plate
Türdrücker auf Langschild
Manilla con placa



KEW_311A

EAN: 5907791123510



KEW_316A

EAN: 5907791118875



satin | satén



KEW_312A

EAN: 5907791123497



satin | satén



KCG_311A

EAN: 5907791111340



satin | satén

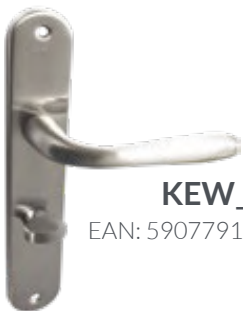

KEW_313A

EAN: 5907791123503



satin | satén



KEW_314A

EAN: 5907791128225



satin | satén

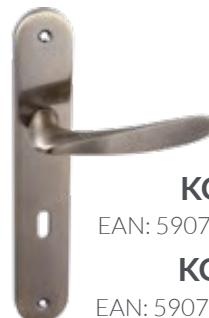

KCG_411A

EAN: 5907791111395



patina | pátina

KCG_316A

EAN: 5907791124012





KCG_312A

EAN: 5907791111357



satin | satén



KCG_313A

EAN: 5907791111364



satin | satén



KCG_314A

EAN: 5907791111371



satin | satén



KCG_412A

EAN: 5907791111401



KCG_315A

EAN: 5907791124005



patina | pátina



KCG_413A

EAN: 5907791111418



patina | pátina



IRYS

Handle with a long plate
Türdrücker auf Langschild
Manilla con placa



KCI_3M1A

EAN: 5907791110077



matte satin | satin matt | satén mate



KCI_3M2A

EAN: 5907791110084



matte satin | satin matt | satén mate



KCI_3M3A

EAN: 5907791110091



matte satin | satin matt | satén mate



KCI_3M4A

EAN: 5907791110107



matte satin | satin matt | satén mate



LUGA II

Handle with a long plate
Türdrücker auf Langschild
Manilla con placa

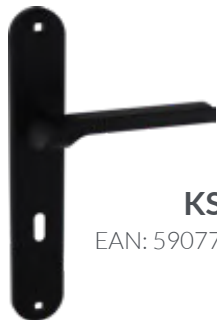

NEW
NEUHEIT
NOVEDAD

KS2_911A

EAN: 5907791188557



black | schwarz | negro

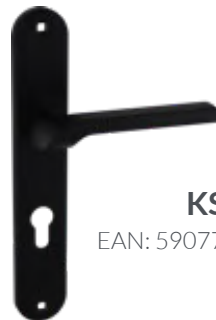

NEW
NEUHEIT
NOVEDAD

KS2_912A

EAN: 5907791188564



black | schwarz | negro

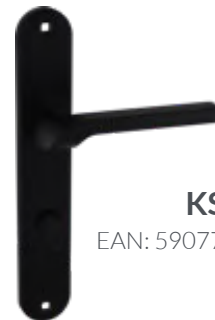

NEW
NEUHEIT
NOVEDAD

KS2_913A

EAN: 5907791188571



black | schwarz | negro



LUXOR

Handle with a long plate
Türdrücker auf Langschild
Manilla con placa



KLU_111A

EAN: 5907791139023



KLU_116A

EAN: 5907791119087



satin | satén / chrome | chrom | cromo

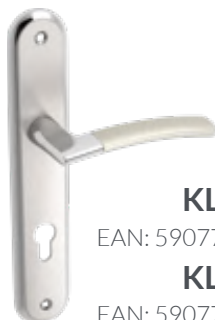

KLU_112A

EAN: 5907791139030



KLU_115A

EAN: 5907791119063



satin | satén / chrome | chrom | cromo



KLU_113A

EAN: 5907791139047



satin | satén / chrome | chrom | cromo



MADERA

Handle with a long plate
Türdrücker auf Langschild
Manilla con placa



KGD_111A

EAN: 5906775348345



satin | satén / chrome | chrom | cromo



KGD_112A

EAN: 5906775348352



satin | satén / chrome | chrom | cromo



KGD_113A

EAN: 5906775348369



satin | satén / chrome | chrom | cromo



MALTA

Handle with a long plate
Türdrücker auf Langschild
Manilla con placa



KLM_3M1A

EAN: 5907791110183



matte satin | satin matt | satén mate



KLM_3M2A

EAN: 5907791110190



matte satin | satin matt | satén mate

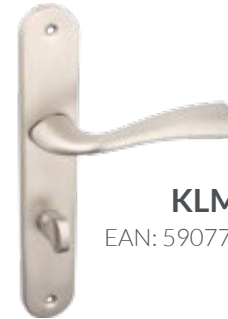

KLM_3M3A

EAN: 5907791110206



matte satin | satin matt | satén mate



NOA

Handle with a long plate
Türdrücker auf Langschild
Manilla con placa

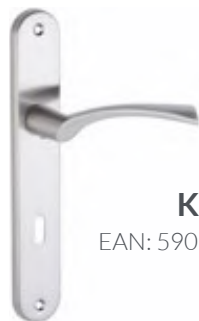

KNA_311A

EAN: 5907791112583



satin | satén

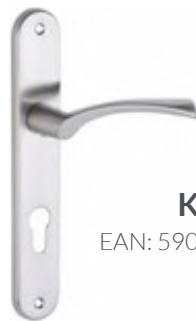

KNA_312A

EAN: 5907791112590



satin | satén

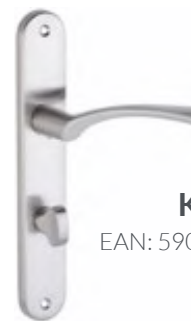

KNA_313A

EAN: 5907791112606



satin | satén

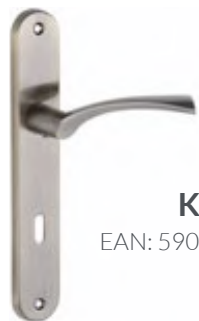

KNA_411A

EAN: 5907791112903



patina | pátina

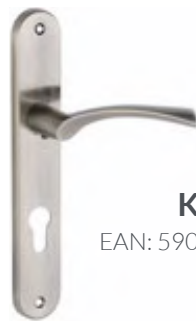

KNA_412A

EAN: 5907791112910



patina | pátina

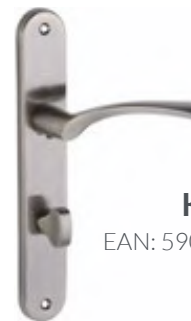

KNA_413A

EAN: 5907791112927



patina | pátina



PARVA

Handle with a long plate
Türdrücker auf Langschild
Manilla con placa



KRV_111A

EAN: 5907791123268



satin | satén / chrome | chrom | cromo



KRV_112A

EAN: 5907791123275



satin | satén / chrome | chrom | cromo



KRV_113A

EAN: 5907791123282



satin | satén / chrome | chrom | cromo



PRIMA

Handle with a long plate
Türdrücker auf Langschild
Manilla con placa

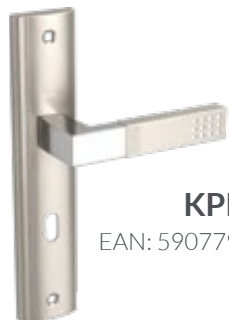

KPR_111A

EAN: 5907791141200



satin | satén / chrome | chrom | cromo

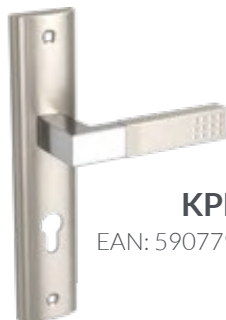

KPR_112A

EAN: 5907791141217



satin | satén / chrome | chrom | cromo



KPR_113A

EAN: 5907791141224



satin | satén / chrome | chrom | cromo



KPR_114A

EAN: 5907791139641



satin | satén / chrome | chrom | cromo



QUBIK

Handle with a long plate
Türdrücker auf Langschild
Manilla con placa



KGQ_311A

EAN: 5907791141262



satin | satén

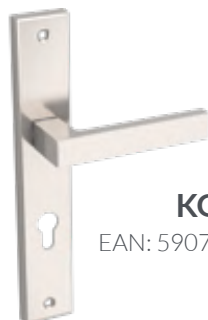

KGQ_312A

EAN: 5907791141279



satin | satén



KGQ_313A

EAN: 5907791141286



satin | saté



RANDO

Handle with a long plate
Türdrücker auf Langschild
Manilla con placa



KRA_911A

EAN: 597791168719



black | schwarz | negro



KRA_912A

EAN: 5907791168726



black | schwarz | negro



KRA_913A

EAN: 5907791168733



black | schwarz | negro



KRA_914A

EAN: 5907791168740



black | schwarz | negro



RETRO

Handle with a long plate
Türdrücker auf Langschild
Manilla con placa



KCR_411A

EAN: 5906775344903



patina | pátina



KCR_412A

EAN: 5906775344897



patina | pátina



KCR_413A

EAN: 5906775344910



patina | pátina



KCR_414A

EAN: 5906775344880



patina | pátina



left | links | izquierda

KCR_432A

EAN: 5906775344972



right | rechts | derecha

KCR_422A

EAN: 5906775344965



patina | pátina



RODOS

Handle with a long plate
Türdrücker auf Langschild
Manilla con placa



KGO_411A

EAN: 5906775348635



KGO_416A

EAN: 5907791119056



patina | pátina



KGO_412A

EAN: 5906775348642



KGO_415A

EAN: 5907791119049



patina | pátina



KGO_413A

EAN: 5906775348659



patina | pátina



KGO_414A

EAN: 5906775348666



patina | pátina



STILO

Handle with a long plate
Türdrücker auf Langschild
Manilla con placa



KCS_411A

EAN: 5906775347225



KCS_416A

EAN: 5907791118868



patina | pátina



KCS_412A

EAN: 5906775347232



KCS_415A

EAN: 5906775347263



patina | pátina



KCS_413A

EAN: 5906775347249



patina | pátina

OUTDOOR HANDLES
AUSSENTÜRDRÜCKER
MANILLAS EXTERIORES



AURIS

Handle with a long plate
Türdrücker auf Langschild
Manilla con placa



FLOKO

Handle with a long plate
Türdrücker auf Langschild
Manilla con placa



Insert
Zylindereinsatz
Cilindro
LZ1_102A

KZA_112A

EAN: 5907791115423



satín | satén | chrome | chrom | cromo



Insert
Zylindereinsatz
Cilindro
LZ3_302A

KZF_312A

EAN: 5907791180599



KZF_318A

EAN: 5907791165855



anodized satín | satín eloxiert | satén anodizado



Insert
Zylindereinsatz
Cilindro
LZ1_4M2A

KZA_4M2A

EAN: 5907791115430



matte patina | patina matt | pátina mate



Insert
Zylindereinsatz
Cilindro
LZ3_402A

KZF_412A

EAN: 5907791165848



anodized patina | patina eloxiert | pátina anodizada



Insert
Zylindereinsatz
Cilindro
LZ3_302A

KZF_322A 
EAN: 5907791180605



anodized satin | satin eloxiert | satén anodizado



Insert
Zylindereinsatz
Cilindro
LZ3_902A

KZF_912A 
EAN: 5907791180612

KZF_918A 
EAN: 5907791113801



anodized black | schwarz eloxiert | negro anodizado



FLOKO series handle
Türdrücker der Serie FLOKO
Manilla de la serie FLOKO



FRIDA

Handle with a long plate
Türdrücker auf Langschild
Manilla con placa



KZC_312L

EAN: 5907791109408



satin | satén



KZC_312P

EAN: 5907791109415



satin | satén



IRMA

Handle with a long plate
Türdrücker auf Langschild
Manilla con placa



KZI_312L

EAN: 5907791118134



satin | satén



KZI_312P

EAN: 5907791118141



satin | satén

GATE HANDLES
TORKLINKEN
MANILLAS PARA PORTONES



BARON

Handle with a long plate
Türdrücker auf Langschild
Manilla con placa



KGR_915A

EAN: 5907791111036



black | schwarz | negro



KGR_925A

EAN: 5907791141439



black | schwarz | negro



KGR_935A

EAN: 5907791141446



black | schwarz | negro



MAGNAT

Handle with a long plate
Türdrücker auf Langschild
Manilla con placa



NEW
NEUHEIT
NOVEDAD

KGR_515S

EAN: 5907791187369



graphite | graphit | grafito



NEW
NEUHEIT
NOVEDAD

KGR_535S

EAN: 5907791187376



graphite | graphit | grafito



KGR_M85S

EAN: 5907791119728



KGR_M15S

EAN: 5907791111630



KGR_M92S

EAN: 5907791119735



black | schwarz | negro



KGR_M35S

EAN: 5907791111623



black | schwarz | negro



MAGNAT

Handle with a long plate
Türdrücker auf Langschild
Manilla con placa



NEW
NEUHEIT
NOVEDAD

KGR_565S

EAN: 5907791187383



graphite | graphit | grafito



KGR_M65S

EAN: 5907791111647



black | schwarz | negro

PLATES
SCHILDER
ROSETAS



SQUARE PLATES | QUADRATISCHE SCHILDER | ROSETAS CUADRADAS

Split plate
Geteiltes Schild
Roseta

KEY
SCHLÜSSEL
LLAVE



LK1_301S



satin | satén
EAN: 5907791112408



LK1_401S



patina | pátina
EAN: 5907791112439



LK1_901A



black | schwarz | negro
EAN: 5907791158970

INSERT
ZYLINDEREINSATZ
CILINDRO



LK1_302S



satin | satén
EAN: 5907791112415



LK1_402S



patina | pátina
EAN: 5907791112446



LK1_902A



black | schwarz | negro
EAN: 5907791158987

TOILET
WC



LK1_303S



satin | satén
EAN: 5907791112422



LK1_403S



patina | pátina
EAN: 5907791112453



LK1_903A



black | schwarz | negro
EAN: 5907791158994



LK2_001B



chrome | chrom | cromo
EAN: 5907791120618



LK2_101B



satin | satén /
chrome | chrom | cromo
EAN: 5907791139603



LK2_201A



satin | satén
EAN: 5907791113139



LK2_301B



satin | satén
EAN: 5907791126504



LK2_002B



chrome | chrom | cromo
EAN: 5907791120625



LK2_102B



satin | satén /
chrome | chrom | cromo
EAN: 5907791139610



LK2_202A



satin | satén
EAN: 5907791113146



LK2_302B



satin | satén
EAN: 5907791126511



LK2_003B



chrome | chrom | cromo
EAN: 5907791120632



LK2_103B



satin | satén /
chrome | chrom | cromo
EAN: 5907791139627



LK2_203A



satin | satén
EAN: 5907791113153



LK2_303B



satin | satén
EAN: 5907791126528



SQUARE PLATES | QUADRATISCHE SCHILDER | ROSETAS CUADRADAS

Split plate
Geteiltes Schild
Roseta

KEY
SCHLÜSSEL
LLAVE



LK2_401B



patina | pátina
EAN: 5907791141361



LK2_501B



graphite | graphit | grafito /
chrome | chrom | cromo
EAN: 5907791128324



LK2_901A



black | schwarz | negro
EAN: 5907791141927

INSERT
ZYLINDEREINSATZ
CILINDRO



LK2_402B



patina | pátina
EAN: 5907791141378



LK2_502B



graphite | graphit | grafito /
chrome | chrom | cromo
EAN: 5907791128331



LK2_902A



black | schwarz | negro
EAN: 5907791141934

TOILET
WC



LK2_403B



patina | pátina
EAN: 5907791141385



LK2_503B



graphite | graphit | grafito /
chrome | chrom | cromo
EAN: 5907791128348



LK2_903A



black | schwarz | negro
EAN: 5907791141941



LK2_921A



black | schwarz | negro
EAN: 5907791165947



LK4_101S



satin | satén /
chrome | chrom | cromo
EAN: 5906775348437



LK4_401S



patina | pátina
EAN: 5906775348468



LK4_501A



graphite | graphit | grafito /
chrome | chrom | cromo
EAN: 5907791125101



LK2_922A



black | schwarz | negro
EAN: 5907791165954



LK4_102S



satin | satén /
chrome | chrom | cromo
EAN: 5906775348444



LK4_402S



patina | pátina
EAN: 5906775348475



LK4_502A



graphite | graphit | grafito /
chrome | chrom | cromo
EAN: 5907791125118



LK2_923A



black | schwarz | negro
EAN: 5907791165961



LK4_103S



satin | satén /
chrome | chrom | cromo
EAN: 5906775348451



LK4_403S



patina | pátina
EAN: 5906775348482



LK4_503A



graphite | graphit | grafito /
chrome | chrom | cromo
EAN: 5907791125125



SQUARE PLATES | QUADRATISCHE SCHILDER | ROSETAS CUADRADAS

Split plate
Geteiltes Schild
Roseta

KEY
SCHLÜSSEL
LLAVE



LK5_001A



chrome | chrom | cromo
EAN: 5907791124241



LK5_101A



satin | satén /
chrome | chrom | cromo
EAN: 5907791124098



LK5_301A



satin | satén
EAN: 5907791124128

INSERT
ZYLINDEREINSATZ
CILINDRO



LK5_002A



chrome | chrom | cromo
EAN: 5907791124258



LK5_102A



satin | satén /
chrome | chrom | cromo
EAN: 5907791124104



LK5_302A



satin | satén
EAN: 5907791124135

TOILET
WC



LK5_003A



chrome | chrom | cromo
EAN: 5907791124265



LK5_103A



satin | satén /
chrome | chrom | cromo
EAN: 5907791124111



LK5_303A



satin | satén
EAN: 5907791124142



LK5_501A



graphite | graphit | grafito/
chrome | chrom | cromo
EAN: 5907791124067



LK5_601A



white | weiß | blanco
EAN: 5907791104236



LK5_801A



rose gold | roségold |
oro rosa
EAN: 5907791188182



LK5_901A



black | schwarz | negro
EAN: 5907791104311



LK5_502A



graphite | graphit | grafito/
chrome | chrom | cromo
EAN: 5907791124074



LK5_602A



white | weiß | blanco
EAN: 5907791104250



LK5_802A



rose gold | roségold |
oro rosa
EAN: 5907791183569



LK5_902A



black | schwarz | negro
EAN: 5907791104335



LK5_503A



graphite | graphit | grafito/
chrome | chrom | cromo
EAN: 5907791124081



LK5_603A



white | weiß | blanco
EAN: 5907791104274



LK5_803A



rose gold | roségold |
oro rosa
EAN: 5907791188199



LK5_903A



black | schwarz | negro
EAN: 5907791104359



SQUARE PLATES

Split plate
Geteiltes Schild
Roseta

2*



ROUND PLATES |

Split plate
Geteiltes Schild
Roseta

KEY
SCHLÜSSEL
LLAVE



NEW
NEUHEIT
NOVEDAD

LK5_G01A



gold | dorado
EAN: 5907791188168

INSERT
ZYLINDEREINSATZ
CILINDRO



NEW
NEUHEIT
NOVEDAD

LK5_G02A



gold | dorado
EAN: 5907791183552

TOILET
WC



NEW
NEUHEIT
NOVEDAD

LK5_G03A



gold | dorado
EAN: 5907791188175

KEY
SCHLÜSSEL
LLAVE



LO1_0M1A



matte chrome / chrom
matt / cromo mate
EAN: 5907791145116

INSERT
ZYLINDEREINSATZ
CILINDRO



LO1_0M2A



matte chrome / chrom
matt / cromo mate
EAN: 597791145123

TOILET
WC



LO1_0M3A



matte chrome / chrom
matt / cromo mate
EAN: 5907791145130



LO1_001S

chrome | chrom | cromo
EAN: 5907791110909



LO1_101S

satin | satén /
chrome | chrom | cromo
EAN: 5907791112224



LO1_201S

satin | satén
EAN: 5907791113160



LO1_301S

satin | satén
EAN: 5907791112255



LO1_002S

chrome | chrom | cromo
EAN: 5907791110916



LO1_102S

satin | satén /
chrome | chrom | cromo
EAN: 5907791112231



LO1_202S

satin | satén
EAN: 5907791113177



LO1_302S

satin | satén
EAN: 5907791112262



LO1_003S

chrome | chrom | cromo
EAN: 5907791110923



LO1_103S

satin | satén /
chrome | chrom | cromo
EAN: 5907791112248



LO1_203S

satin | satén
EAN: 5907791113184



LO1_303S

satin | satén
EAN: 5907791112279



ROUND PLATES | RUNDSCHILDER | ROSETAS REDONDAS

Split plate
Geteiltes Schild
Roseta

KEY
SCHLÜSSEL
LLAVE



NEW
NEUHEIT
NOVEDAD

LO1_3M1A



matte satin | satin matt
| satén mate
EAN: 5907791187338



LO1_3M1S



matte satin | satin matt
| satén mate
EAN: 5907791112316



LO1_401S



patina | pátina
EAN: 5907791111913

INSERT
ZYLINDEREINSATZ
CILINDRO



NEW
NEUHEIT
NOVEDAD

LO1_3M2A



matte satin | satin matt
| satén mate
EAN: 5907791187345



LO1_3M2S



matte satin | satin matt
| satén mate
EAN: 5907791112323



LO1_401S



patina | pátina
EAN: 5907791111920

TOILET
WC



NEW
NEUHEIT
NOVEDAD

LO1_3M3A



matte satin | satin matt |
satén mate
EAN: 5907791187352



LO1_3M3S



matte satin | satin matt |
satén mate
EAN: 5907791112330



LO1_403S



patina | pátina
EAN: 5907791111937



LO1_4M1A



matte patina | patina matt |
pátina mate
EAN: 5907791122674



LO1_801A



rose gold | roségold |
oro rosa
EAN: 5907791188120

NEW
NEUHEIT
NOVEDAD

LO1_901A



black | schwarz | negro
EAN: 5907791165411

NEW
NEUHEIT
NOVEDAD

LO1_911A



black | schwarz | negro
EAN: 5907791191984



LO1_4M2A



matte patina | patina matt |
pátina mate
EAN: 5907791122681



LO1_802A



rose gold | roségold |
oro rosa
EAN: 5907791183583

NEW
NEUHEIT
NOVEDAD

LO1_902A



black | schwarz | negro
EAN: 5907791165428

NEW
NEUHEIT
NOVEDAD

LO1_912A



black | schwarz | negro
EAN: 5907791191991



LO1_4M3A



matte patina | patina matt |
pátina mate
EAN: 5907791122698



LO1_803A



rose gold | roségold |
oro rosa
EAN: 5907791188151

NEW
NEUHEIT
NOVEDAD

LO1_903A



black | schwarz | negro
EAN: 5907791165435

NEW
NEUHEIT
NOVEDAD

LO1_913A



black | schwarz | negro
EAN: 5907791192004



ROUND PLATES | RUNDSCHILDER | ROSETAS REDONDAS

Split plate
Geteiltes Schild
Roseta

KEY
SCHLÜSSEL
LLAVE



NEW
NEUHEIT
NOVEDAD

LO1_921A



black | schwarz | negro
EAN: 5907791187307



NEW
NEUHEIT
NOVEDAD

LO1_G01A



gold | dorado
EAN: 5907791188106



LO2_001S



chrome | chrom | cromo
EAN: 5907791128805

INSERT
ZYLINDEREINSATZ
CILINDRO



NEW
NEUHEIT
NOVEDAD

LO1_922A



black | schwarz | negro
EAN: 5907791187314



NEW
NEUHEIT
NOVEDAD

LO1_G02A



gold | dorado
EAN: 5907791183576



LO2_002S



chrome | chrom | cromo
EAN: 5907791128812

TOILET
WC



NEW
NEUHEIT
NOVEDAD

LO1_923A



black | schwarz | negro
EAN: 5907791187321



NEW
NEUHEIT
NOVEDAD

LO1_G03A



gold | dorado
EAN: 5907791188113



LO2_003S



chrome | chrom | cromo
EAN: 5907791128829

**LO2_301S**

satin | satén
EAN: 5907791112347

**LO2_401S**

patina | pátina
EAN: 5907791112378

**LO3_301A**

satin | satén
EAN: 5907791112682

**LO2_302S**

satin | satén
EAN: 5907791112354

**LO2_402S**

patina | pátina
EAN: 5907791112385

**LO3_302A**

satin | satén
EAN: 5907791112699

**LO2_303S**

satin | satén
EAN: 5907791112361

**LO2_403S**

patina | pátina
EAN: 5907791112392

**LO3_303A**

satin | satén
EAN: 5907791112705



OUTDOOR PLATES | AUSSENSCHILDER | ROSETAS EXTERIORES

2*

Split plate
Geteiltes Schild
Roseta



LZ1_102A



satin | satén /
chrome | chrom | cromo
EAN: 5907791115447



LZ1_4M2A



matte patina | patina
matt | pátina mate
EAN: 5907791115454



LZ3_302A



anodized satin | satin
eloxiert | satén anodizado
EAN: 5907791115652



LZ3_402A



anodized patina | eloxierte
patina | patina anodizada
EAN: 5907791116581



LZ3_902A



anodized black | schwarz
eloxiert | negro anodizado
EAN: 5907791130549



LZ4_302A



satin | satén /
EAN: 5907791130167



LZ4_402A



patina | pátina
EAN: 5907791130174



LZ5_102A



satin | satén /
chrome | chrom | cromo
EAN: 5907791130198

ACCESSORIES
ZUBEHÖR
ACCESORIOS



BUMPERS | STOPPER | TOPES

Door bumpers
Türstopper
Topes para puertas



LAO_311M



satin | satén
EAN: 5907791141392



LAO_411M



patina | pátina
EAN: 5907791141408



NEW
NEUHEIT
NOVEDAD

LAO_911M



black | schwarz | negro
EAN: 5907791181114



LAO_324M



satin | satén
EAN: 5907791141415



LAO_424M



patina | pátina
EAN: 5907791103512



NEW
NEUHEIT
NOVEDAD

LAO_924M



black | schwarz | negro
EAN: 5907791181121



LAO_334A



satin | satén
EAN: 5907791127877



LAO_434A



patina | pátina
EAN: 5907791109842



NEW
NEUHEIT
NOVEDAD

LAO_934A



black | schwarz | negro
EAN: 5907791181138



LAO_735M

transparent | transparente
EAN: 5907791122148



BUMPERS
STOPPER
TOPES



INSERTS | ZYLINDEREIN- SÄTZE | CILINDROS

Cylinder inserts | Schließzylinder | Cilindros

2*



SETS | CONJUNTOS

Mounting kit for handles with a pin
Montageset für Türdrücker mit Stift
Conjunto de montaje para manillas con vástago



brass
messing
latón

3 keys
3 Schlüssel
3 llaves

WBB_022M

30x30 mm

EAN: 5906775349199



cast iron
gusseisen
hierro fundido

3 keys
3 Schlüssel
3 llaves

WBB_322N

30x30 mm

EAN: 5907791129130

WBB_345N

40x50 mm

EAN: 5907791148148

WBB_327N

30x50 mm

EAN: 5907791129185



LZM_310A

95 mm

EAN: 5906775349625



satin | satén



LZM_320A

120 mm

EAN: 5906775349656



satin | satén



LZM_410A

95 mm

EAN: 5906775349663

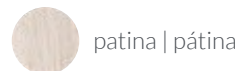

patina | pátina



LZM_420A

120 mm

EAN: 5906775349670



patina | pátina

WARDROBES
GARDEROBEN
ARMARIOS

The word wardrobe is most often associated with a separate room in which clothes are stored. However, this phrase also means a special type of furniture that can be placed anywhere. These elements of interior are divided to mobile (with a possibility to move it easily) and fixed. Let's learn the advantages of each of those above.

MOBILE WARDROBES (WITH WHEELS)

These are light furniture, usually made of steel and plastic, recommended for small apartments, plots, dormitories or the set. Equipped with 4 wheels which, after placing the product in the right place, are locked with a simple mechanism. Most often they have one or two bars for hanging clothes, on which, e.g. hanging, folded, non-woven shelves dedicated for storing shoes are also placed. The mentioned bars, depending on a model of wardrobe, can be adjusted by length as well as height, thanks to which the furniture can be easily fitted to the amount of clothes to be put in and size of the room. A huge advantage here is that we can easily assemble the whole structure which takes only a few minutes.

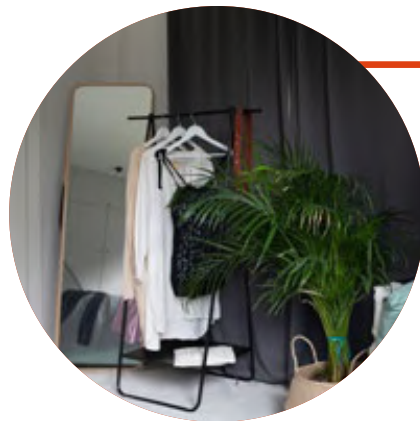

FIXED WARDROBES

They offer a large number of shelves, a style and hence a very high functionality, as they can be dedicated to a bedroom or a hall. They are equipped with, e.g. shelves for shoes or clothes and plenty of hangers. They can perfectly keep order in both small and big rooms and optimize the space so clothes are all in the right place. Mostly they are made of steel with the most fashionable black finish or a combination of harmonious brown and black, thanks to which the interior will be given a modern, loft character. Depending on the needs, everyone can find the perfect wardrobe for themselves.

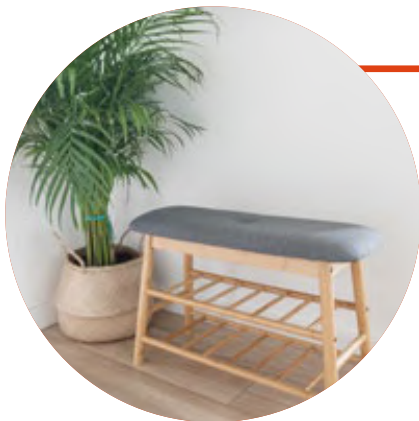

FOOTWEAR STANDS

They are undoubtedly a convenient and at the same time practical solution for keeping our halls neat. They don't require a lot of space and can also play a decorative role in our apartments. Depending on the needs, they can be equipped with 2, 3 or even 4 shelves, thanks to which they are perfect for bigger families, too. Different kinds of materials, such as steel or bamboo, were used in their production, what gives them a minimalistic style combined with environmental protection and the design. To ensure the comfort and safety while putting on or taking off the shoes, stands are equipped with a soft seat.

WARDROBE ACCESSORIES

They are undoubtedly a convenient and at the same time practical solution for keeping our halls neat. They don't require a lot of space and can also play a decorative role in our apartments. Depending on the needs, they can be equipped with 2, 3 or even 4 shelves, thanks to which they are perfect for bigger families, too. Different kinds of materials, such as steel or bamboo, were used in their production, what gives them a minimalistic style combined with environmental protection and the design. To ensure the comfort and safety while putting on or taking off the shoes, stands are equipped with a soft seat.



Das Wort Garderobe wird meistens mit einem separaten Raum in Verbindung gebracht, in dem wir Kleidung aufbewahren. Dieser Ausdruck bedeutet jedoch auch spezielle Arten von Möbeln, die an beliebigen Orten aufgestellt werden. Wir unterteilen diese Einrichtungs-elemente in mobile (leicht bewegliche) und feste. Lassen Sie uns die Vorteile jedes der oben genannten Arten kennenlernen.

MOBILE GARDEROBEN (AUF RÄDERN)

Es handelt sich dabei um leichte Möbel, die am häufigsten aus einer Kombination von Stahl und Kunststoff hergestellt werden und für kleine Wohnungen, Kleinkarten, Wohnheime oder Filmsets empfohlen werden. Sie sind mit 4 Rädern ausgestattet, die man, sobald das Produkt in Position ist, durch einen einfachen Mechanismus blockiert. Meistens verfügen sie über eine oder zwei Stangen zum Aufhängen von Kleidung, an denen z. B. auch faltbare Schuhhängeregale aus Vlies angebracht sind. Diese Stangen können je nach Garderobenmodell in Bezug auf sowohl die Länge und als auch die Höhe der Position gleichermaßen angepasst werden, wodurch die Möbel leicht an die Anzahl der besessenen Kleidungsstücke und die Abmessungen des Raumes angepasst werden können. Ein großes Plus ist auch die sehr einfache Montage der gesamten Konstruktion, die nur wenige Minuten in Anspruch nehmen wird.

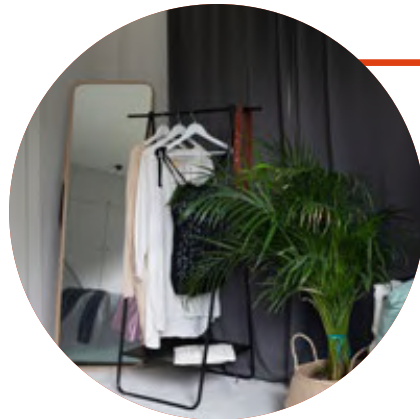

FESTSTEHENDE GARDEROBEN

Sie bieten eine große Anzahl von Ablagen, Stil und daher eine sehr hohe Funktionalität, da sie sowohl einem Schlafzimmer als auch dem Flur gewidmet werden können. Sie sind z. B. mit Ablagen für Schuhe oder Kleidung und einer großen Anzahl von Kleiderhaken ausgestattet. Sie helfen perfekt dabei, sowohl in kleinen als auch in großen Räumen Ordnung zu halten und den Platz optimal zu nutzen, damit alle Kleidungsstücke ihren Platz finden. Sie sind in der Regel aus Stahl in der angesagtesten schwarzen Ausführung oder einer Kombination aus passender Bronze mit Schwarz gefertigt, wodurch das Interieur einen modernen, loftartigen Charakter erhält. Je nach Bedarf kann jeder die für sich perfekte Garderobe finden.



SCHUHSTÄNDER

Sie sind zweifellos eine bequeme und gleichzeitig praktische Lösung, um im Flur Ordnung zu halten. Man braucht nicht viel Platz, um sie aufzustellen, und sie können auch als dekoratives Element in der Wohnung dienen. Je nach Bedarf sind sie mit 2, 3 oder sogar 4 Ablagen ausgestattet, dank derer sie auch für größere Familien geeignet sind. Bei ihrer Herstellung wurden verschiedene Materialien wie Stahl und Bambus verwendet, dank denen sie in einem minimalistischen Stil gehalten sind, der Umweltfreundlichkeit und Design miteinander verbindet. Aus Gründen des Komforts und der Sicherheit beim An- und Ausziehen der Schuhe ist das Regal mit einem weichen Sitz ausgestattet.

GARDEROBEN-ZUBEHÖR

Praktische Vliesboxen in gedämpften Ausführungen erhöhen den Stauraum im Schlafzimmer und passen zu fast jedem Regal und Interieur. Sie bestehen aus einem strapazierfähigen Material mit Griffen, wodurch sie sehr leicht herausgezogen werden können. Sie dienen zur Aufbewahrung aller möglichen Dinge: Kleidung, Schuhe, Bettzeug, Decken, Kinderspielzeug und Kosmetika. Die Boxen sind mit Deckeln ausgestattet, was die Lagerung noch einfacher macht, da sich im Inneren kein Staub ansammelt. Darüber hinaus gibt es spezielle Wäsche-Organizer mit 4, 9 oder 12 Fächern. Alle Organizer und Boxen lassen sich einfach und bequem zusammenfolden und schnell verstauen.



La palabra armario normalmente se asocia con un espacio separado en el que guardamos la ropa. Sin embargo, este término también designa un tipo especial de mueble que puede colocarse en cualquier lugar. Estos elementos del equipamiento los dividimos en móviles (con posibilidad de un fácil desplazamiento) y fijos. Conozcamos las ventajas de cada uno de los tipos anteriores.

ARMARIOS MÓVILES (SOBRE RUEDAS)

Son muebles ligeros, normalmente contruidos con una combinación de acero y plástico, recomendados para viviendas pequeñas, huertos, residencias de estudiantes o localizaciones. Están equipados con 4 ruedas que, tras colocar el producto en el lugar adecuado, se bloquean mediante un sencillo mecanismo. Por lo general tienen una o dos barras dedicadas a colgar la ropa, en las que se colocan también, por ejemplo, estantes colgantes plegables de no tejido destinados para guardar el calzado. Las mencionadas barras, en función del modelo de armario, pueden ser reguladas tanto en longitud como en altura de colocación, gracias a lo cual adaptamos muy rápidamente el mueble a la cantidad de ropa que tenemos y las dimensiones del espacio. Una enorme ventaja es también el muy sencillo plegado de toda la estructura, que lleva apenas unos minutos.

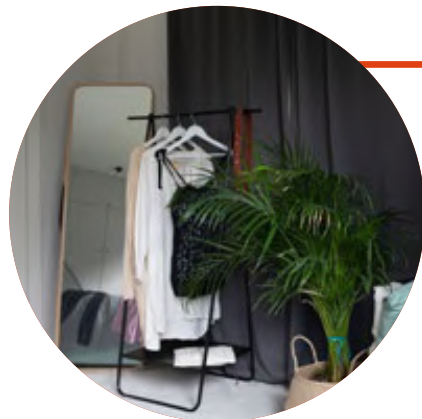

ARMARIOS FIJOS

Ofrecen un gran número de estantes, estilo y, por lo tanto, una gran funcionalidad, ya que pueden colocarse en el dormitorio o el vestíbulo. Están equipados con estantes para calzado o ropa y un gran número de colgadores. Ayudan perfectamente a mantener el orden en habitaciones tanto pequeñas como grandes y a optimizar el uso del espacio, de manera que toda la ropa tenga su lugar.

Normalmente se fabrican en acero acabado en el negro más de moda, o bien en una combinación armonizada de marrón y negro, gracias a lo cual el interior recibe un moderno carácter de estilo loft. En función de las necesidades, todo el mundo puede encontrar su armario ideal.

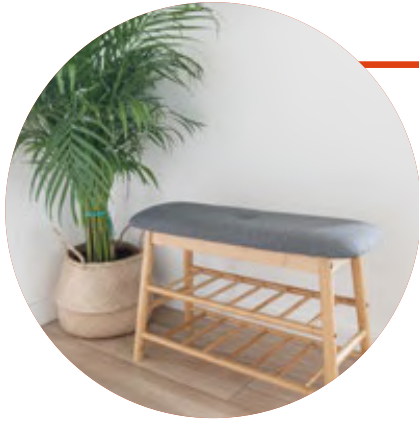

MUEBLES ZAPATEROS

Sin duda son una solución cómoda y al mismo tiempo práctica para mantener el orden en el vestíbulo. Para su colocación no es necesario mucho espacio y también pueden desempeñar el papel de elemento decorativo en la vivienda.

En función de las necesidades, están equipados con 2, 3 e incluso 4 estantes, gracias a lo cual también son apropiados para familias grandes. Para su fabricación se utilizan diferentes materiales, tales como el acero o el bambú, gracias a lo cual conservan un estilo minimalista, que combina el cuidado por el medio ambiente y el diseño. Velando también por la comodidad y la seguridad al ponerse y quitarse el calzado, el mueble ha sido equipado con un asiento blando.

ACCESORIOS PARA ARMARIOS

Las prácticas cajas de no tejido en acabados armonizados aumentan el espacio de almacenamiento en el dormitorio y combinarán con prácticamente cualquier estante e interior. Han sido fabricadas en un resistente material con asas, por lo que retirarlas es muy sencillo. Están dedicadas para guardar diferentes tipos de cosas: ropa, calzado, sábanas, mantas, juguetes para niños, cosméticos. Las cajas tienen tapa, por lo que el almacenamiento es aún más sencillo debido al hecho de que el polvo no se acumula en su interior. Además, hay unos organizadores especiales para ropa interior con 4, 9 o 12 paredes. Todos los organizadores y las cajas pueden plegarse de forma sencilla y guardarse rápidamente.





MAJA

Wall hangers
Wandaufhänger
Colgadores de pared

2*



PAULO

Mobile Wardrobes
Mobile Garderobe
Armario móvil

2*



NEW
NEUHEIT
NOVEDAD

GKM_300S

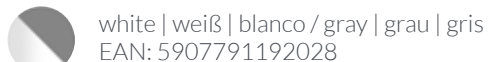

white | weiß | blanco / gray | grau | gris
EAN: 5907791192028

43x43x78 mm / 70x70x82 mm
carrying load: 2kg
Tragfähigkeit: 2 kg
capacidad de carga: 2 kg



NEW
NEUHEIT
NOVEDAD

GKM_700S



white | weiß | blanco / black | schwarz | negro
EAN: 5907791192035

50x50x78 mm / 85x85x82 mm
carrying load: 2kg
Tragfähigkeit: 2 kg
capacidad de carga: 2 kg



GKA_210R



chrome | chrom | cromo / black | schwarz | negro
EAN: 5907791116628

950-1600x850-1300x420 mm
1 bar / 1 Stange / 1 barra
carrying load: 15 kg
Tragfähigkeit der Stange: 15 kg
capacidad de carga: 15 kg

2*

PAULO BISMobile Wardrobes
Mobile Garderobe
Armario móvil

2*

JACOBStanding wardrobes
Garderobenständer
Armarios de pie**GKA_220R**chrome | chrom | cromo /
black | schwarz | negro
EAN: 5907791116642950-1600x850-1300x420 mm
2 bars / 2 Stange / 2 barras
carrying load: 15 kg
Tragfähigkeit der Stange: 15 kg
capacidad de carga: 15 kgWardrobe JACOB
Garderobe JACOB
Armario JACOB**GKJ_792S**black | schwarz | negro /
brown | braun | marrón
EAN: 59077911811451800x700x320 mm
2 shelves, 9 bar racks, seat
carrying load: 1,5 kg bar rack
10 kg metal shelf
80 kg wooden shelf
2 Ablagen, 9 Aufhänger, Sitz
Tragfähigkeit: 1,5 kg Aufhänger
10 kg Metallablage
80 kg Holzablage
2 estantes, 9 colgadores, asiento
capacidad de carga: 1,5 kg colgador
10 kg estante metálico
80 kg estante de madera



LOFT II

Standing wardrobes
Garderobenständer
Armarios de pie

2*

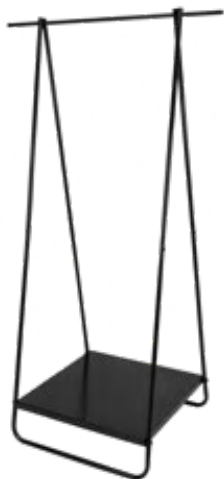

GKL_710S



black | schwarz | negro
EAN: 5907791182029

1400x520x470 mm

1 bar / 1 stange / 1 barra

carrying load: 10 kg bar

20 kg shelf

Tragfähigkeit: 10 kg Stange

20 kg Ablage

capacidad de carga: 10 kg barra

20 kg estante



Wardrobe LOFT II
Garderobe LOFT II
Armario LOFT II

2*

LIVIA

Standing wardrobes
Garderobenständer
Armarios de pie



2*

ZOSIA BIS

Standing wardrobes
Garderobenständer
Armarios de pie



GKI_710S



black | schwarz | negro /
brown | braun | marrón
EAN: 5907791187154

1600x500x400 mm

1 bar / 1 Stange / 1 barra

carrying load: 10 kg

Tragfähigkeit: 2 kg

capacidad de carga: 2 kg



GKZ_753S



graphite | graphit | grafito
EAN: 5907791120557

1800x750x300 mm

3 shelves, 5 bar racks

carrying load: 20 kg

3 Ablagen, 5 Aufhänger

Tragfähigkeit: 20 kg

3 estantes, 5 colgadores

capacidad de carga: 20 kg estante



TOLA

Footwear stand
Schuhständer
Mueble zapatero

2*



TOLA BIS

Footwear stand
Schuhständer
Mueble zapatero

2*



DGA_021M



chrome | chrom | cromo
EAN: 5906775349045

DGA_421M



graphite | graphit | grafito
EAN: 5907791120397

670x500x250 mm

3 shelves | 3 Ablagen | 3 estantes

carrying load: 40 kg

Tragfähigkeit: 40 kg

capacidad de carga: 40 kg



DGA_022M



chrome | chrom | cromo
EAN: 5906775349052

DGA_422M



graphite | graphit | grafito
EAN: 5907791120403

850x750x250 mm

4 shelves | 4 Ablagen | 4 estantes

carrying load: 60 kg

Tragfähigkeit: 60 kg

capacidad de carga: 60 kg

2*

ZOJA
Footwear stand
Schuhständer
Mueble zapatero



GKZ_402S



gray | grau | gris / brown | braun | marrón
EAN: 5907791185976

450x700x240 mm

2 shelves | 2 Ablagen | 2 estantes

carrying load: 8 kg shelves

100 kg seat

Tragfähigkeit: 8 kg Ablagen

100 kg Sitz

capacidad de carga: 8 kg estantes

100 kg asiento



Footwear stand ZOJA
Schuhständer ZOJA
Mueble zapatero ZOJA



FLORIDA

Wardrobe accessories
Garderoben-Zubehör
Accesorios para armarios



GFL_425M



beige
EAN: 5907791160140

950x280x280 mm
5 shelves | 5 Ablagen | 5 estantes



GFL_428M



beige
EAN: 5907791160157

950x280x280 mm
8 shelves | 8 Ablagen | 8 estantes



GFL_4B01



beige
EAN: 5907791160164

400x250x300 mm



GFL_4B02



beige
EAN: 5907791160171

600x300x400 mm



GFL_4B03



beige
EAN: 5907791160188

600x400x500 mm



GFL_4B04



beige
EAN: 5907791160195

280x330x150 mm



GFL_4B05



beige
EAN: 5907791160201

360x480x190 mm



GFL_4B06



beige
EAN: 5907791160218

310x310x310 mm



GFL_4B07



beige
EAN: 5907791160225

150x150x310 mm



GFL_4B08



beige

EAN: 5907791160232

150x310x310 mm



GFL_4B10



beige

EAN: 5907791160256

380x290x165 mm



GFL_4B12



beige

EAN: 5907791160270

300x300x155 mm



GFL_4B09



beige

EAN: 5907791160249

270x270x280 mm



GFL_4B11



beige

EAN: 5907791160263

380x290x325 mm



GFL_4B13



beige

EAN: 5907791160287

600x450x300 mm





JAMAJKA

Wardrobe accessories
Garderoben-Zubehör
Accesorios para armarios



NEW
NEUHEIT
NOVEDAD

GJA_425M

white | weiß | blanco /
graphite | graphit | grafito
EAN: 5907791189783

280x280x950 mm
5 shelves | 5 Ablagen | 5 estantes



NEW
NEUHEIT
NOVEDAD

GJA_4B05

white | weiß | blanco /
graphite | graphit | grafito
EAN: 5907791189813

360x480x190 mm



NEW
NEUHEIT
NOVEDAD

GJA_4B12

white | weiß | blanco /
graphite | graphit | grafito
EAN: 5907791189844

300x300x155 mm



NEW
NEUHEIT
NOVEDAD

GJA_4B01

white | weiß | blanco /
graphite | graphit | grafito
EAN: 5907791189790

400x250x300 mm



NEW
NEUHEIT
NOVEDAD

GJA_4B09

white | weiß | blanco /
graphite | graphit | grafito
EAN: 5907791189820

270x270x280 mm



NEW
NEUHEIT
NOVEDAD

GJA_4B13

white | weiß | blanco /
graphite | graphit | grafito
EAN: 5907791189851

600x450x300 mm



NEW
NEUHEIT
NOVEDAD

GJA_4B04

white | weiß | blanco /
graphite | graphit | grafito
EAN: 5907791189806

280x330x150 mm



NEW
NEUHEIT
NOVEDAD

GJA_4B10

white | weiß | blanco /
graphite | graphit | grafito
EAN: 5907791189837

380x290x165 mm



NEW
NEUHEIT
NOVEDAD

GJA_4B14

white | weiß | blanco /
graphite | graphit | grafito
EAN: 5907791189868

330x230x90 mm



NEW
NEUHEIT
NOVEDAD

GJA_4B15



white | weiß | blanco /
graphite | graphit | grafito
EAN: 5907791189875

265x265x130 mm



NEW
NEUHEIT
NOVEDAD

GJA_4B16



white | weiß | blanco /
graphite | graphit | grafito
EAN: 5907791189882

450x360x120 mm



NEW
NEUHEIT
NOVEDAD

GJA_4B17



white | weiß | blanco /
graphite | graphit | grafito
EAN: 5907791189899

320x320x570 mm



NEW
NEUHEIT
NOVEDAD

GPH_4MPL



white | weiß | blanco /
graphite | graphit | grafito
EAN: 5907791189905

550x70x1100 mm



NEW
NEUHEIT
NOVEDAD

GPH_4SPL



white | weiß | blanco /
graphite | graphit | grafito
EAN: 5907791189912

550x70x850 mm



MIAMI

Wardrobe accessories
Garderoben-Zubehör
Accesorios para armarios



GMA_425M



beige
EAN: 5907791160294

280x280x950 mm
5 shelves | 5 Ablagen | 5 estantes



GMA_428M



beige
EAN: 5907791160300

280x280x950 mm
8 shelves | 8 Ablagen | 8 estantes



GMA_4B01



beige
EAN: 5907791160317

400x250x300 mm



GMA_4B02



beige
EAN: 5907791160324

600x300x400 mm



GMA_4B03



beige
EAN: 5907791160331

600x400x500 mm



GMA_4B04



beige
EAN: 5907791160348

280x330x150 mm



GMA_4B05



beige
EAN: 5907791160355

360x480x190 mm



GMA_4B06



beige
EAN: 5907791160362

310x310x310 mm



GMA_4B07



beige
EAN: 5907791160379

150x150x310 mm

**GMA_4B08**

beige

EAN: 5907791160386

150x310x310 mm

**GMA_4B09**

beige

EAN: 5907791160393

270x270x280 mm

**GMA_4B10**

beige

EAN: 5907791160409

380x290x165 mm

**GMA_4B11**

beige

EAN: 5907791160416

380x290x325 mm

**GMA_4B12**

beige

EAN: 5907791160423

300x300x155 mm

**GMA_4B13**

beige

EAN: 5907791160430

600x450x300 mm

**GPH_2MPL**

beige

EAN: 5907791160119

550x70x1100 mm

**GPH_2SPL**

beige

EAN: 5907791160133

550x70x850 mm



KUCHINOX

INSPIRATION COMES FROM THE INSIDE

KUCHINOX POLSKA SP.Z O.O. SP.K.
AL.KOŚCIUSZKI 3, 90-418 ŁÓDŹ

CUSTOMER SERVICE OFFICE
KUNDENDIENSTBÜRO
OFICINA DE ATENCIÓN AL CLIENTE

BOK@KUCHINOX.PL

TEL: +48 42 715 40 53

+48 42 715 40 56

+48 42 715 40 33

+48 42 715 40 34

+48 42 715 40 87

+48 42 639 74 99

WWW.KUCHINOX.PL